



C



# ANEXOS



C

12

OBRA: PAVIMENTAÇÃO EM PEDRA TOSCA –LARANJEIRAS  
ENDEREÇO: RUA DA PENHA- MUNICÍPIO DE BANABUIÚ  
DATA: 28.05.2020

**RELATÓRIO FOTOGRÁFICO**



  
Cláudia Vilas Bôas  
Eng<sup>o</sup> Civil  
CREA-CE 14365-0

OBRA: PAVIMENTAÇÃO EM PEDRA TOSCA –LARANJEIRAS  
ENDEREÇO: RUA DA IGREJA, LARANJEIRAS - MUNICÍPIO DE BANABUIÚ  
DATA: 03.06.2020

**RELATÓRIO FOTOGRÁFICO**



14

  
Cláudia Vilas Bôas  
Eng<sup>o</sup> Civil  
CREA - CE 14365-0



RUA DA IGREJA -----  
 COOR.UTM  
 INICIO: N:514716.85 / E:9415258.53  
 FINAL :N:514845.24 / E:9415205.67

RUA ESTRADA DA PENHA -----  
 COOR.UTM  
 INICIO: N:514901.90 / E:9415220.61  
 FINAL : N:515030.28 / E:9415279.05

CONDIÇÕES DE INTERESSAO

PERFIL	ESP.	COR.
01	0.40	PRETO
02	0.20	PRETO
03	0.10	PRETO
04	0.25	PRETO
05	0.10	PRETO
06	0.25	PRETO
07	0.40	PRETO
08	0.10	PRETO

TAB. 01 - 20/04/2016



PROJETO	PAVIMENTAÇÃO EM PEDRA TOSCA -DISTRITO LARANJEIRA
CONTRATANTE	GOVERNO MUNICIPAL DE BANABUIÚ -CE
ENDEREÇO	RUA DA IGREJA E RUA ESTRADA DA PENHA
CONTEÚDO	PLANTA DE LOCALIZAÇÃO

Claudia Villas Boas  
 Eng. Civil - CREA-CE/14365-D  
 Prefeitura Municipal de Banabuiú

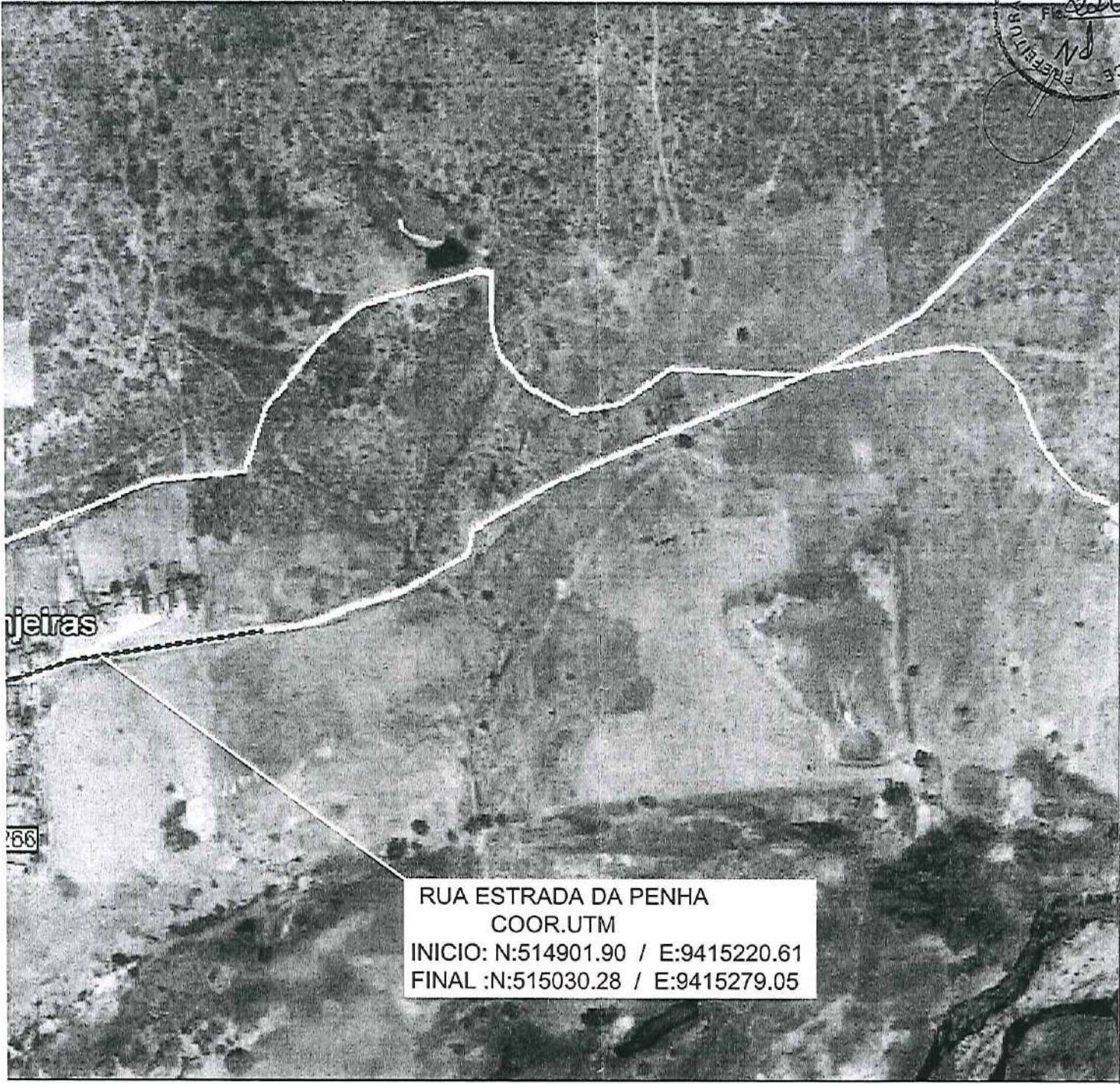

jeiras

66

**RUA ESTRADA DA PENHA**  
**COORDENADAS UTM**  
**INICIO: N:514901.90 / E:9415220.61**  
**FINAL :N:515030.28 / E:9415279.05**

AP

TÍTULO GEOMÉTRICO		RESPONSÁVEL		DATA	ESCALA
<b>PLANTA</b> CERCA: — x — x — EIXO PROJETO: ———— BUEIRO CAPEADO:       BUEIRO TUBULAR:	<b>LEGENDA PERFIL</b> PROJETO: ———— TERRENO NATURAL: ————	<b>CLAUDIA VILLAS BOAS</b> DESENHO: MARCOS EXTENSÃO: VARIADAS LARGURA: VARIADAS	MAIO/2020	INDICADA	<b>01-01</b>

OBRA: PAVIMENTAÇÃO EM PEDRA TOŠCA C/ CALÇADA EM CONCRETO  
ENDEREÇO: RUA ALDEBRANO MARTINS S/N - MUNICÍPIO DE BANABUIÚ  
DATA: 28.05.2020

RELATÓRIO FOTOGRÁFICO



  
Cláudia Vilas Boas  
Eng. Civil  
CREA-CE 31080-0

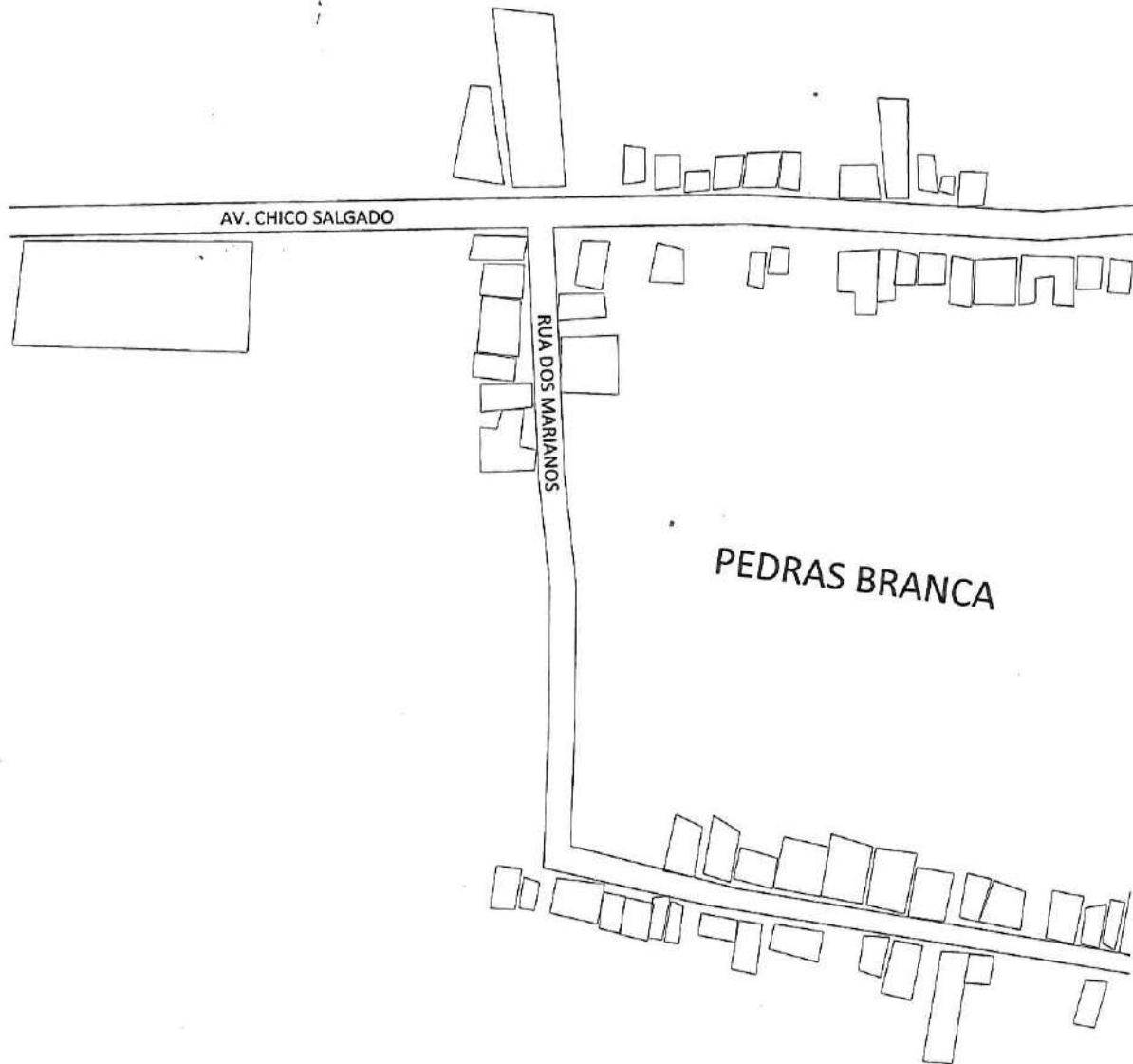

*Cláudia Vilas Bôas*  
 Cláudia Vilas Bôas  
 Eng. Civil  
 CREA-CE 14365-D



PROJETO	MAPA DE LOCALIZAÇÃO
CONTRATANTE	GOVERNO MUNICIPAL DE BANABUIÚ - CE
ENDEREÇO	RUA IDELBRANO BERNARDINHO DA SILVA - PEDRAS BRANCA - BANABUIÚ - CE
CONTEÚDO	PLANTA DE LOCALIZAÇÃO

PLANTA DE

LEGENDA DO  
 LOCAL

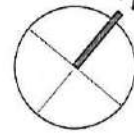

# RUA ALDEBRANO MARTINS PAVIMENTAÇÃO EM PEDRA TOSCA

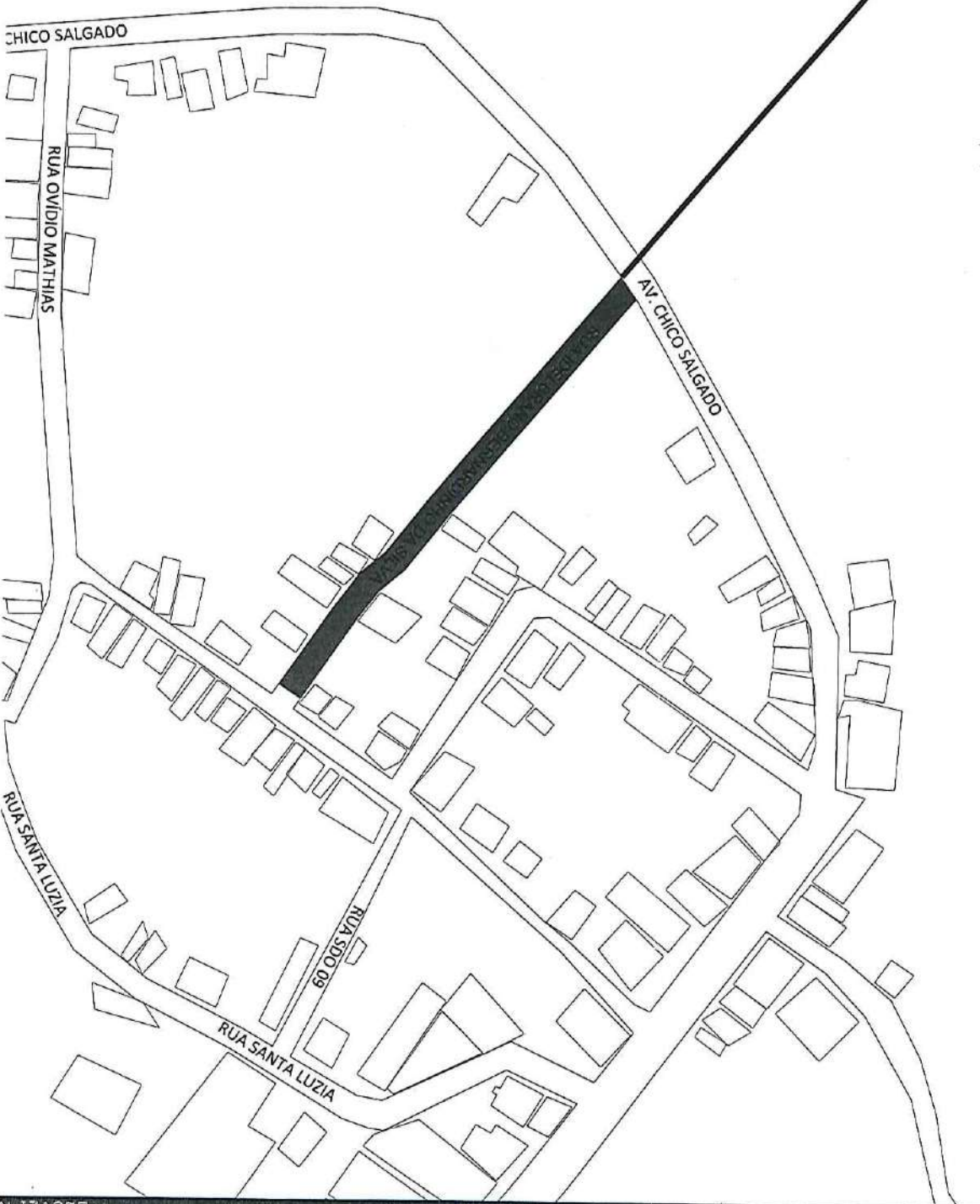

REALIZAÇÃO							
NO	LEGENDA PERFIL	RESPONSÁVEL	CLAUDIA VILLAS BOAS	DATA	MAI/2020	ESCALA	S/E
3	— PROJETO	DESENHO	SAM LIMA	<b>01-03</b>			
	— TERRENO NATURAL		-				
			-				



PLANTA BAIXA  
Escala - 1:1000

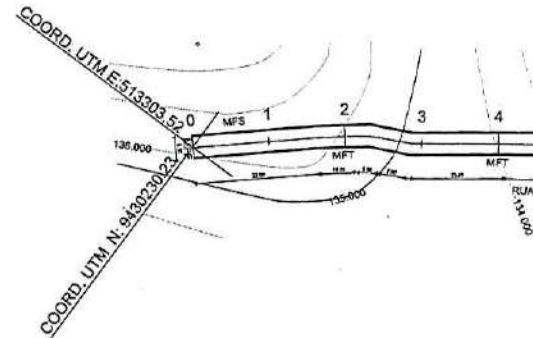

LEGENDA:

- (MFS) MEIO FIO COM SARJETA
- (MFF) MEIO FIO DE FECHAMENTO
- (MFT) MEIO FIO DE TRAVAMENTO

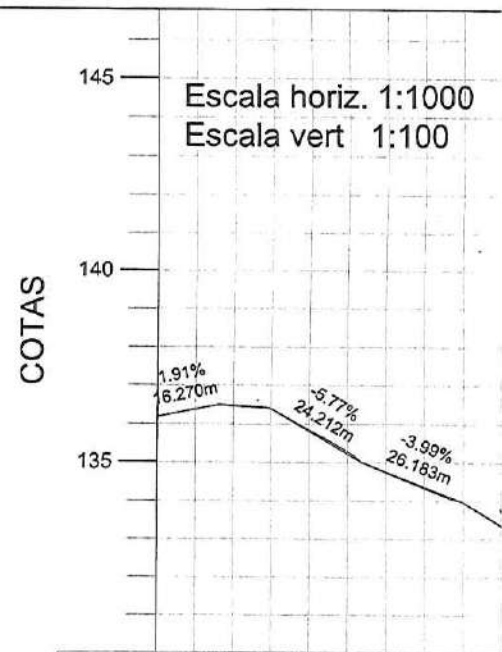

ESTACAS	0	1	2	3	4
TERRENO GREIDE	136,17	136,45	136,45	135,80	135,80
CORTE ATERRO	0,00	0,00	0,00	0,00	0,00



PROJETO	PAVIMENTAÇÃO EM PEDRA TOSCA	PROJETO GE LEGENDA PI IMÓVIL AÇUCAR VIAS
CONTRATANTE	GOVERNO MUNICIPAL DE BANABUIÚ - CEARÁ	
ENDEREÇO	RUA IDELBRAVO BERNARDINHO DA SILVA - PEDRAS BRANCA - BANABUIÚ - CE	
CONTEÚDO	PLANTA E PERFIL	

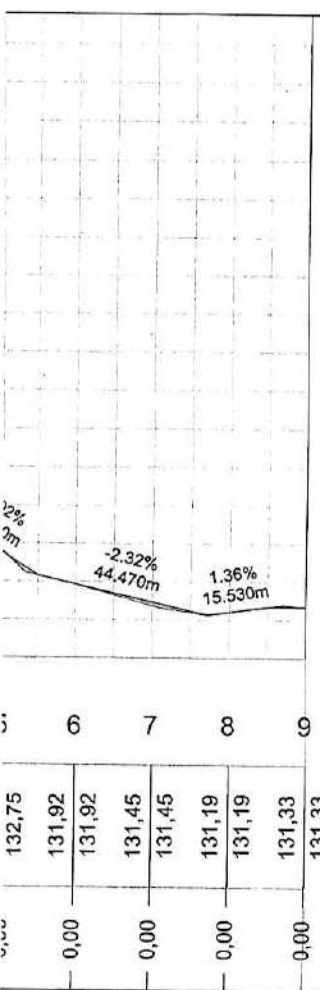
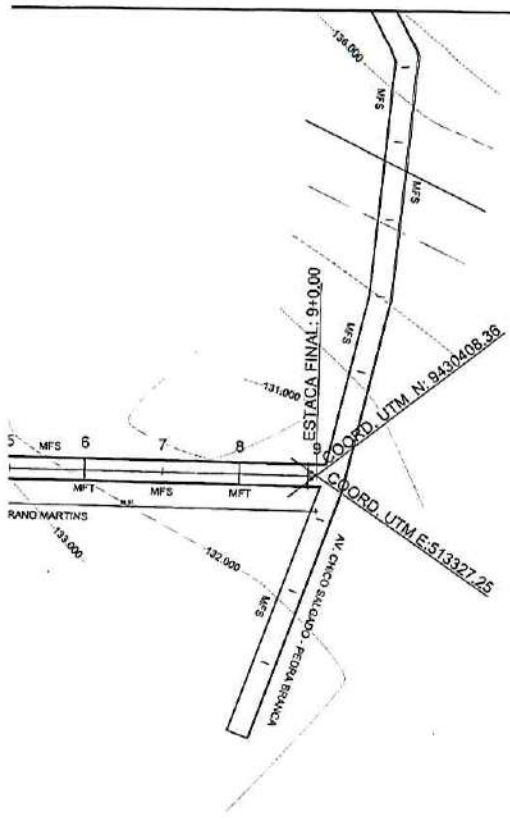
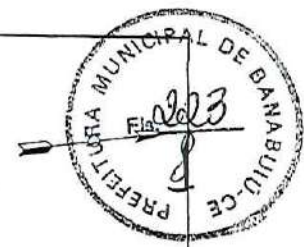

5	6	7	8	9
132,75	131,92	131,92	131,45	131,45
0,00	0,00	0,00	0,00	0,00
131,33	131,33	131,19	131,19	131,33

*Claudia Villas Boas*  
 Cláudia Villas Boas  
 Eng<sup>a</sup> Civil  
 CREA-CE 143665-D

<b>MÉTRICO</b>		<b>LEGENDA PERFIL</b>		<b>RESPONSÁVEL</b>	<b>CLAUDIA VILLAS BOAS</b>	<b>DATA</b>	<b>ESCALA</b>
A	X-X	CERCA	PROJETO	DESENHO	SAM LIMA	ABR/2020	INDICADA
LAGOAS	(((	BUEIRO CAPEADO	TERRENO NATURAL	EXTENSÃO	180,00m	<b>02-03</b>	
CESSO	)))	BUEIRO TUBULAR		LARGURA	5,00 m		

A SIMPLES  
O DA SILVA - PEDRAS BRANCA  
m À 9+0.00 m

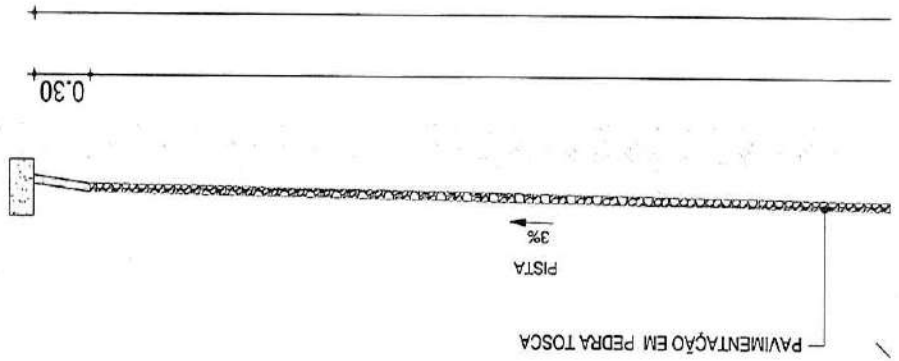

04 | DETALHE DA MEIO FIO CONJUGADO COM SARJETA  
ESC.: 1/10

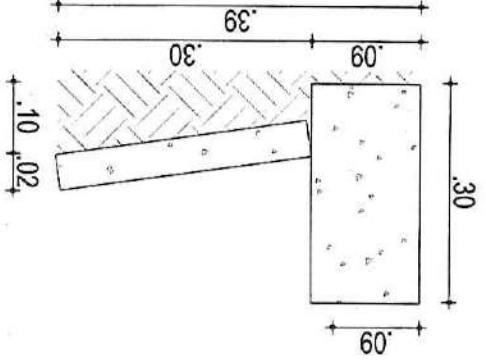

*Claudia Villas Boas*  
Claudia Villas Boas  
Eng.ª CIVIL  
CREA - CE 21955-0

PROJETO GEOMÉTRICO

PROJETO	PAVIMENTAÇÃO EM PEDRA TOSCA	ASSUNTO	PAVIMENTAÇÃO	DATA	19/05/2020	ESCALA	S/F
CLIENTE	GOVERNO MUNICIPAL DE BANABUIÚ - CEARÁ	RESPONSÁVEL	CLAUDIA VILLAS BOAS				
EMPRESA	RUA IDELBRANCO BERNARDINHO DA SILVA - PEDRAS BRANCA - MUNICÍPIO DE BANABUIÚ - CE	DESENHO	SAM LIMA				
CONTÍDUO	SEÇÃO TIPO DE PAVIMENTAÇÃO - DETALHES CONSTRUTIVO - MEIO FIO PEDRA GRANÍTICA E SARJETA DE CONCRETO						



03-03



04 | DETALHE 04 - MEIO FIO CONJUGADO COM SARJETA  
ESC.: 1/10

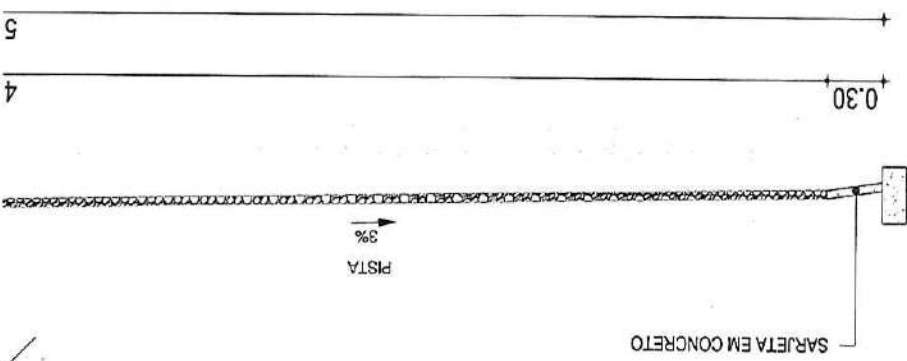
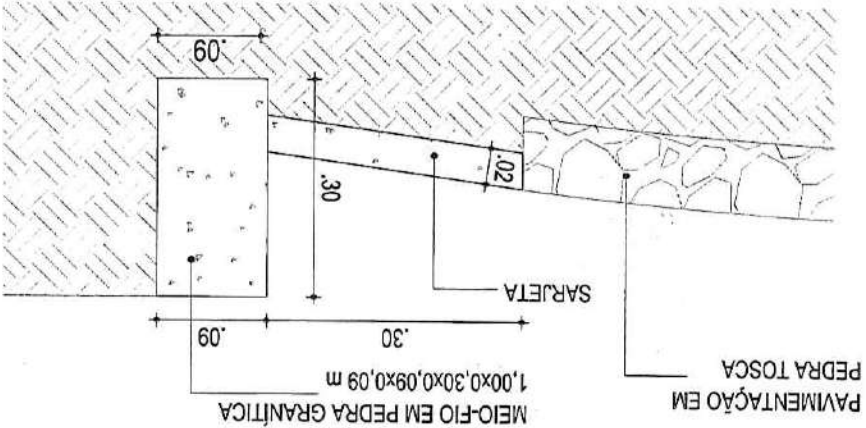

TRECHO PI:  
RUA IDELBRAVO BERNARDIN  
ESTACAS: 0+0,1

12

OBRA: PAVIMENTAÇÃO EM PEDRA TOSCA C/ CALÇADA EM CONCRETO  
ENDEREÇO: RUA DOS MARIANOS S/N - MUNICÍPIO DE BANABUIÚ  
DATA: 28.05.2020

**RELATÓRIO FOTOGRÁFICO**



  
Cláudia Vilas Bôas  
Esp.º Civil  
CREA-CE 14365-0

# RUA DOS MARIANOS PAVIMENTAÇÃO EM PEDRA TOSCA

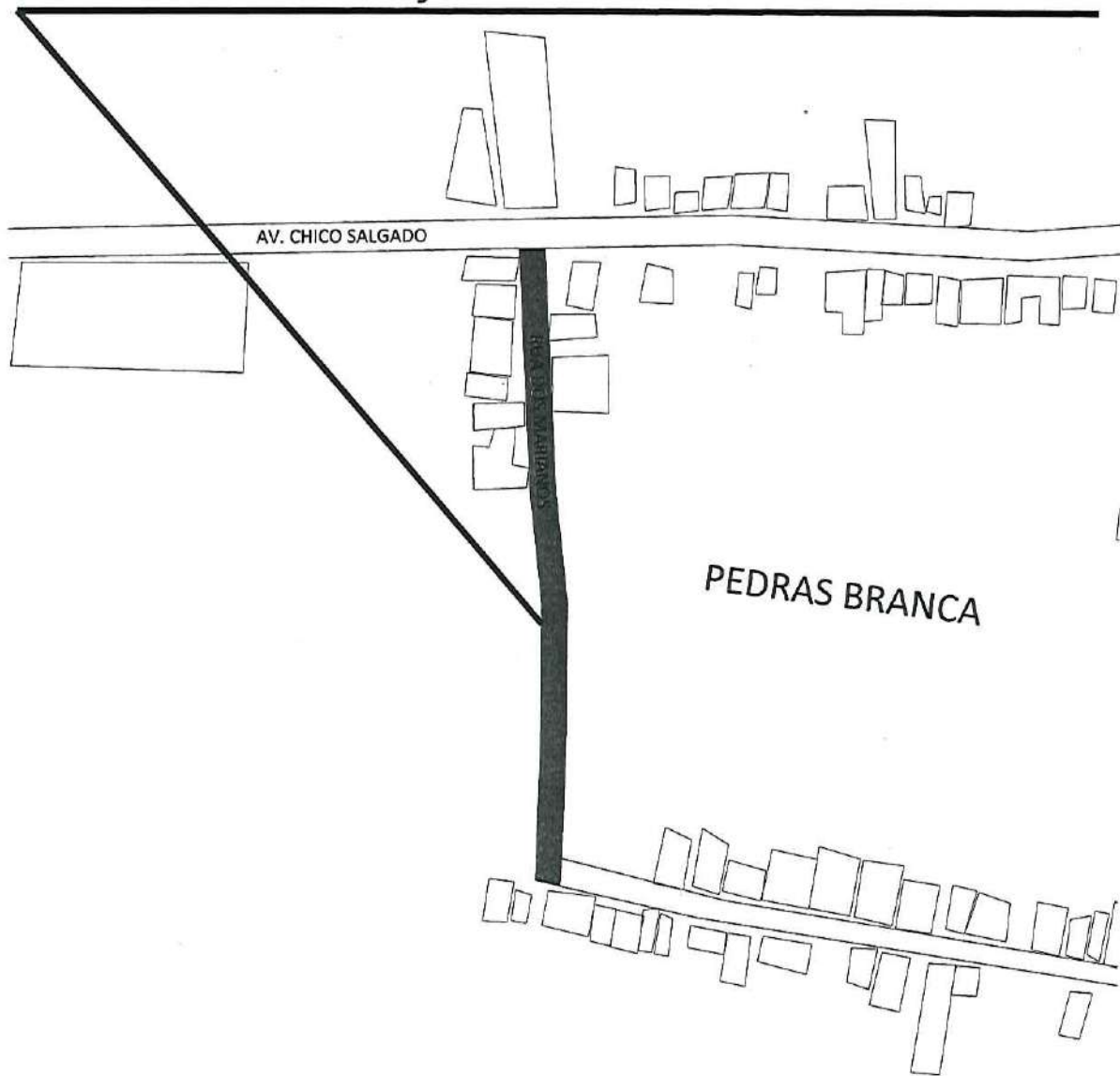

PLANTA DE LOCALIZAÇÃO



PROJETO	MAPA DE LOCALIZAÇÃO	LEGENDA DO LOCAL
CONTRATANTE	GOVERNO MUNICIPAL DE BANABUIÚ - CE	
ENDEREÇO	RUA DOS MARIANOS - PEDRAS BRANCA - BANABUIÚ - CE	
CONTEÚDO	PLANTA DE LOCALIZAÇÃO	

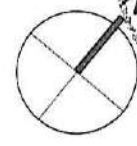



ALIZAÇÃO		RESPONSÁVEL		DATA	ESCALA
PROJETO		CLAUDIA VILLAS BOAS		MAI/2020	S/E
TERRENO NATURAL		DESENHO		01-03	
		SAM LIMA			

*Claudia Villas Boas*  
Cláudia Villas Boas  
Eng. Civil  
CREA-CE 21365-0

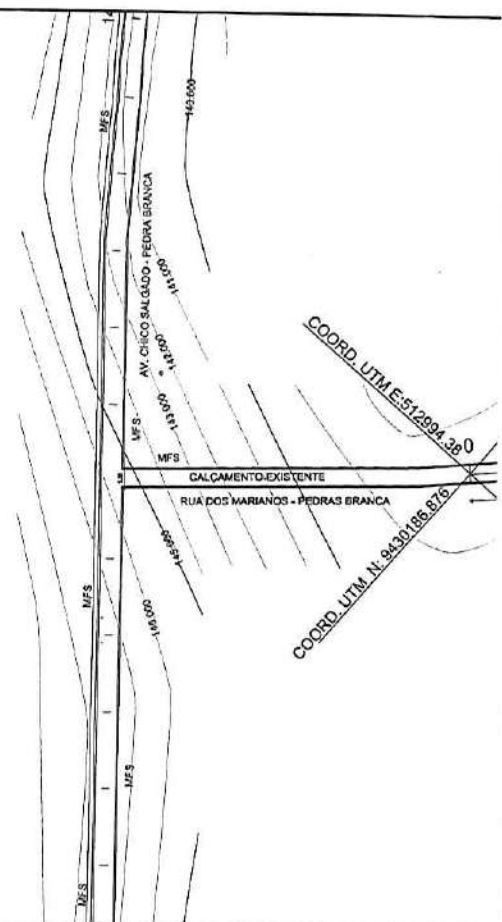
PLANTA BAIXA  
Escala - 1:1000

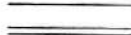

LEGENDA:

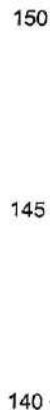

-  (MFS) MEIO FIO COM SARJETA
-  (MFF) MEIO FIO DE FECHAMENTO
-  (MFT) MEIO FIO DE TRAVAMENTO

COTAS



CORTE ATERRO	0,00
TERRENO GREIDE	145,24
ESTACAS	0

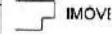
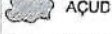

PROJETO	PAVIMENTAÇÃO EM PEDRA TOSCA	LEGENDA PL  IMOVE  AÇUD  VIAS I
CONTRATANTE	GOVERNO MUNICIPAL DE BANABUIÚ - CEARÁ	
ENDEREÇO	RUA DOS MARIANOS - PEDRAS BRANCA - BANABUIÚ - CE	
CONTEÚDO	PLANTA E PERFIL	

PROJETO GE





PROJETO GEOMÉTRICO

PROJETO	PAVIMENTAÇÃO EM PEDRA TOSCA		ASSUNTO	PAVIMENTAÇÃO	DATA: 15/05/2020	ESCALA	S/E
CLIENTE	GOVERNO MUNICIPAL DE BANABUIU - CEARÁ		RESPONSÁVEL	CLAUDIA VILLAS BOAS	03-03		
ENDEREÇO	RUA DOS MARIANOS - PEDRAS BRANCA - MUNICÍPIO DE BANABUIU - CE		DESENHO	SAMI LIMA			
CONTEÚDO	SEÇÃO TIPO DE PAVIMENTAÇÃO - DETALHES CONSTRUTIVO - MEIO FIO PEDRA GRANÍTICA E SARJETAS DE CONCRETO						

*Claudia Villas Boas*  
 Claudia Villas Boas  
 CREA: 153/191-4

A SIMPLES  
 - PEDRAS BRANCA  
 m À 5+5.00 m

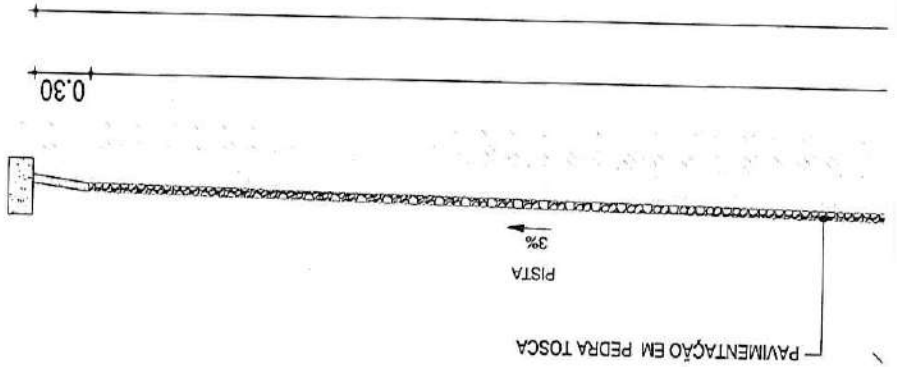

04 DETALHE DA MEIO FIO CONJUGADO COM SARJETA ESC.: 1/10

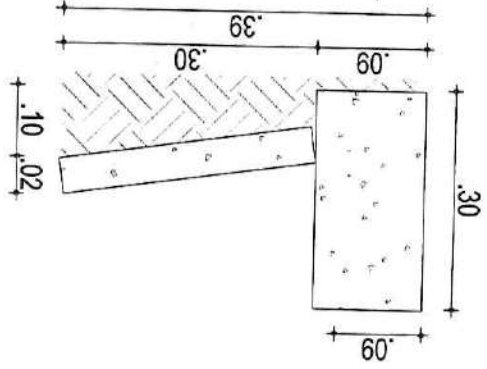



## PLANILHA ORÇAMENTÁRIA

OBRA:	IMPLANTACÃO DE GALERIA EM CONCRETO ARMADO (2,0mX2,0m)PARA A AGUAS PLUVIAIS - SEGMENTO DE 180,00m DE EXTENSAO	DATA :	25/05/2018
ENDERECO:	SEGMENTO LOCALIZADO ENTRE A RUA JOAQUIM LOPES PIMENTA E A RUA IRMA TAVARES - CENTRO - MUNICIPIO DE BANABUIUC	FONTE:	VERBAO
CLIENTE:	PREFEITURA MUNICIPAL DE BANABUIU	SEINFRA	024.1 COM DESONERACAO COMPOSICOES PROPRIAS
		SEINFRA	87,01% - 03/2016
		BDI :	28,38%

ITEM	CODIGO	DESCRICAO	FONTE	UNIDADE	QTD	VALOR UNITARIO R\$		PRECO TOTAL R\$	
						SEM BDI	COM BDI	SEM BDI	COM BDI
1		SERVICOS PRELIMINARES							
1.1	C1937	PLACAS PADRAO DE OBRA	SEINFRA	M2	12,00	128,31	164,72	1.539,72	1.976,64
1.2	C3161	DESMATAMENTO DESTOCAMENTO DE ARVORE E LIMPEZA	SEINFRA	M2	1.242,00	0,22	0,28	273,24	347,76
1.3	C2873	LOCAÇÃO DA OBRA COM AUXILIO TOPOGRAFICO (AREA ATÉ 5000 M2)	SEINFRA	M2	1.242,00	0,29	0,37	360,18	459,54
2		MOVIMENTO DE TERRA							
2.1	C3182	ESCAVAÇÃO CARGA TRANSP. 1-CAT ATÉ 200M	SEINFRA	M3	1.991,40	7,17	9,20	14.278,34	18.320,88
2.2	C3319	NIVELAMENTO DE FUNDO DE VALAS	SEINFRA	M2	468,00	3,59	4,61	1.690,12	2.167,48
2.3	C2920	REATERRRO C/COMPACTAÇÃO MECÂNICA, E CONTROLE, MATERIAL DA VALA	SEINFRA	M3	780,35	14,22	18,26	11.096,58	14.249,19
3		FUNDAÇÕES E ESTRUTURAS							
3.1	C4151	ARMADURA DE AÇO CA 50/60	SEINFRA	KG	22.680,00	7,21	9,26	163.522,80	210.016,80
3.2	C1402	FORMA PLANA CHAPA COMPENSADA RESINADA, ESP = 10mm P/GALERIA E BUEIROS CAPEADOS	SEINFRA	M2	1.908,00	40,42	51,89	77.121,36	99.006,12
3.3	C0843	CONCRETO PVI/BR., FCK 25 MPa COM AGREGADO ADQUIRIDO	SEINFRA	M3	235,80	331,80	425,96	78.238,44	100.441,37
3.4	C1609	LASTRO DE CONCRETO INCLUIDO PREPARO E LANÇAMENTO	SEINFRA	M3	46,80	364,22	467,59	17.045,50	21.883,21
3.5	C0184	ARGAMASSA DE CIMENTO E AREIA PEN. TRAÇO 1:3	SEINFRA	M3	18,00	595,08	763,95	10.711,44	13.751,28
4		ADMINISTRAÇÃO DA OBRA							
4.1	CP-01	ADMINISTRAÇÃO DA OBRA	PROPRIA	MES	6,00	2.248,00	2.885,98	13.488,00	17.315,88
						VALOR ORÇAMENTO:		389.355,72	
						VALOR BDI TOT:		110.570,43	
						VALOR TOTAL:		499.926,15	

Quatrocentos e Noventa e Nove Mil Novcentos e Vinte e Seis reais e Quinze centavos

Mendes & Irlles  
Eng. Civil  
CREA-CE 14365-D

OBRA: PAVIMENTAÇÃO EM PEDRA TOSCA C/ CALÇADA EM CONCRETO  
ENDEREÇO: AVENIDA CHICO SALGADO - MUNICÍPIO DE BANABUIÚ  
DATA: 28.05.2020

**RELATÓRIO FOTOGRÁFICO**



AV. CHICO HONÓRIO  
PAVIMENTAÇÃO EM PEDRA

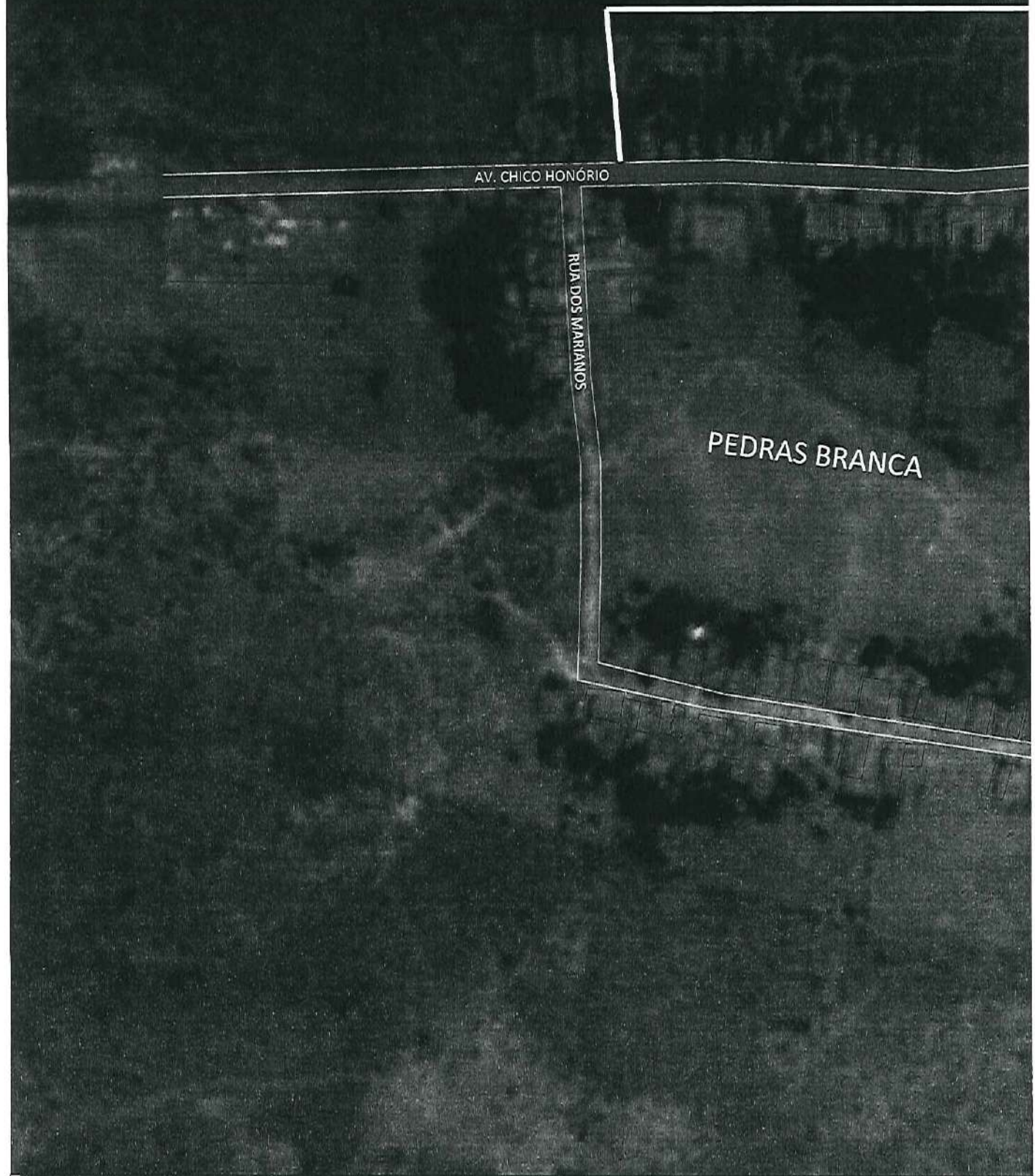

PLANTA DE LOCALIZAÇÃO



PROJETO	MAPA DE LOCALIZAÇÃO	LEGENDA DO LOCAL
CONTRATANTE	GOVERNO MUNICIPAL DE BANABUIÚ - CE	
ENDEREÇO	AV. CHICO HONÓRIO - PEDRAS BRANCA - BANABUIÚ - CE	
CONTEÚDO	PLANTA DE LOCALIZAÇÃO	



TOSCA



ALIZAÇÃO



 Claudia Villas Boas Eng. Civil CREA-CE 12585-0	<b>LEGENDA PERFIL</b> — PROJETO — TERRENO NATURAL	<b>RESPONSÁVEL</b> CLAUDIA VILLAS BOAS	<b>DATA</b> MAIO/2020	<b>ESCALA</b> S/E
		<b>DESENHO</b> SAM LIMA	<b>01-03</b>	
		-		

132

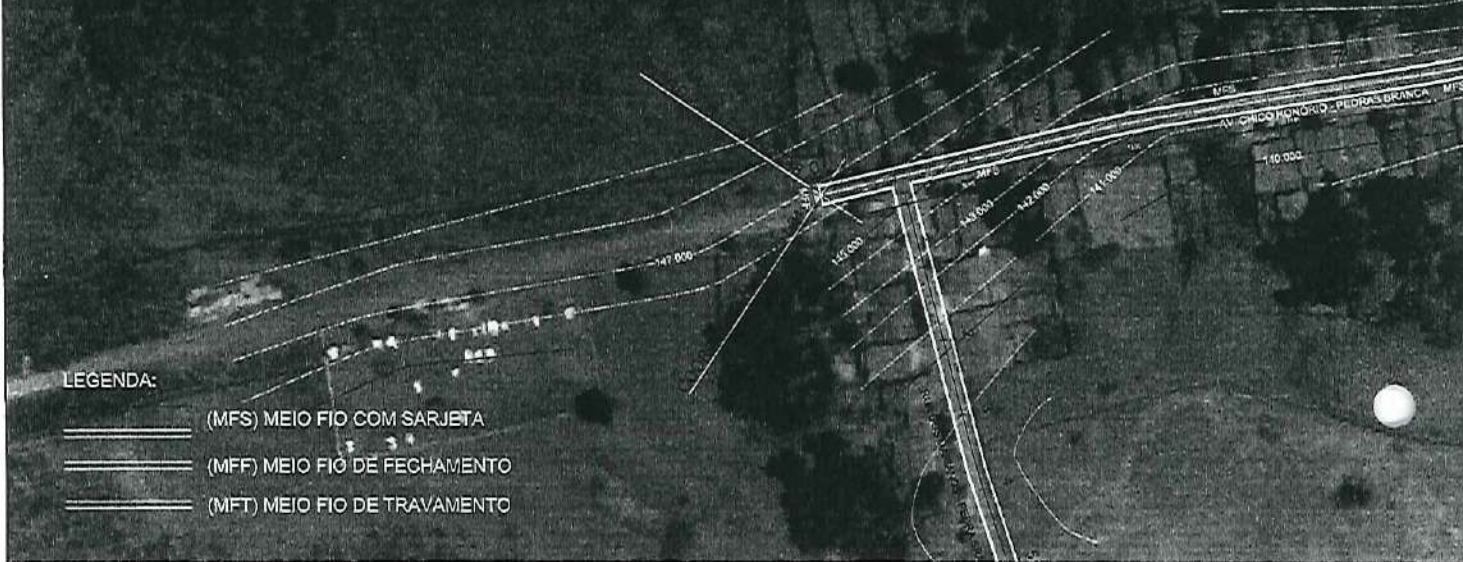
PLANTA BAIXA  
Escala - 1:1000



LEGENDA:

-  (MFS) MEIO FIO COM SARJETA
-  (MFF) MEIO FIO DE FECHAMENTO
-  (MFT) MEIO FIO DE TRAVAMENTO

COTAS

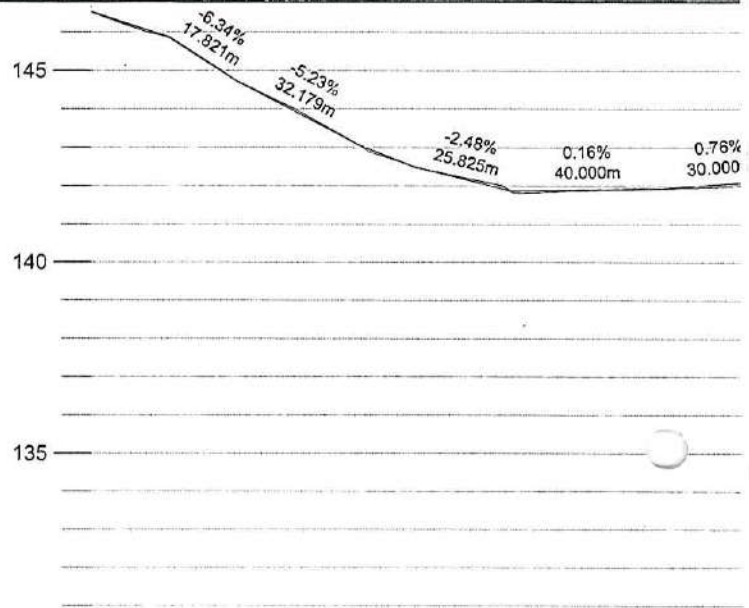



ESTACAS	0	1	2	3	4	5	6	7	8
TERRENO GREIDE	146,53	145,88	144,65	143,64	142,66	142,16	141,84	141,90	141,96
CORTE ATERRO	0,00	0,00	0,00	0,00	0,00	0,00	0,00	0,00	0,00



PROJETO	PAVIMENTAÇÃO EM PEDRA TOSCA
CONTRATANTE	GOVERNO MUNICIPAL DE BANABUIÚ - CE
ENDEREÇO	AV CHICO HONÓRIO - PEDRAS BRANCA - BANABUIÚ - CE
CONTEÚDO	PLANTA E PERFIL

PROJETO GE

-  IMÓV
-  AÇUC
-  VIAS



Escala horiz. 1:1000  
Escala vert 1:100

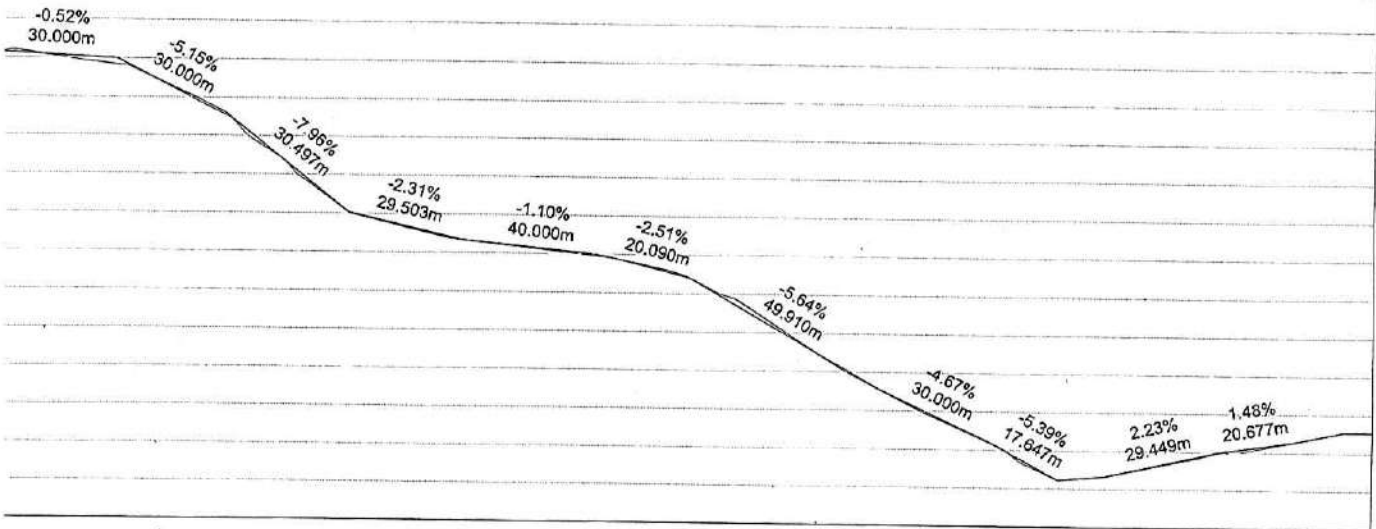

10	11	12	13	14	15	16	17	18	19	20	21	22	23	24	25	26	27																				
142,16	141,97	141,97	141,49	141,49	140,45	140,45	138,80	138,80	137,78	137,78	137,34	137,34	137,15	137,15	136,90	136,90	136,40	136,40	135,38	135,38	134,10	134,10	133,07	133,07	132,18	132,18	131,25	131,25	131,54	131,54	131,99	131,99	132,29	132,29	132,55	132,55	
0,00	0,00	0,00	0,00	0,00	0,00	0,00	0,00	0,00	0,00	0,00	0,00	0,00	0,00	0,00	0,00	0,00	0,00	0,00	0,00	0,00	0,00	0,00	0,00	0,00	0,00	0,00	0,00	0,00	0,00	0,00	0,00	0,00	0,00	0,00	0,00	0,00	0,00

**ÉTRICO**

A — X — CERCA  
 — EIXO PROJETO  
 LAGOAS — BUEIRO CAPEADO  
 CESSO — BUEIRO TUBULAR

**LEGENDA PERFIL**  
 — PROJETO  
 — TERRENO NATURAL

RESPONSÁVEL: CLAUDIA VILLAS BOAS  
 DESENHO: SAM LIMA  
 EXTENSÃO: 340,00m  
 LARGURA: 5,00 m

DATA: MAIO/2020  
 ESCALA INDICADA: 02-03

*Claudia Villas Boas*  
 CREA CE 13365-D



TRECHO PIST  
AV CHICO HONÓRIC  
ESTACAS: 0+0.00

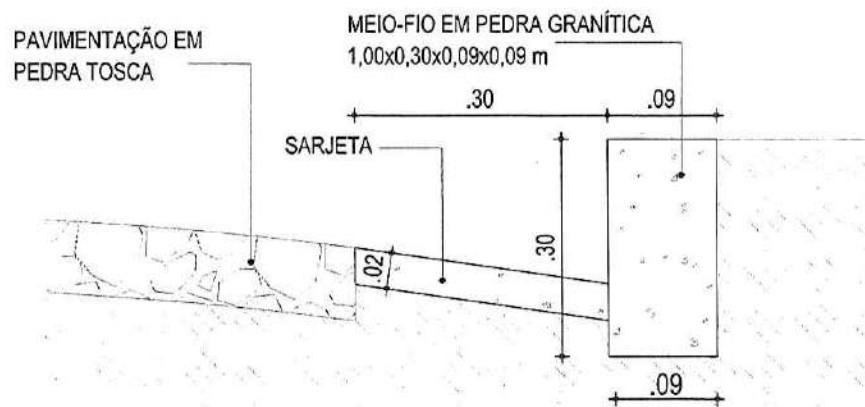
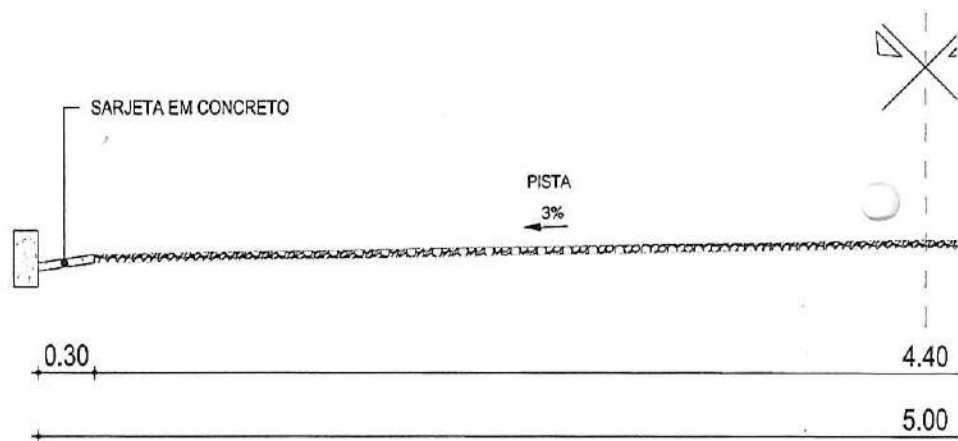

04 | DETALHE 04 - MEIO FIO CONJUGADO COM SARJETA  
ESC.: 1/10

SIMPLES  
 PEDRAS BRANCA  
 À 27+0.00 m

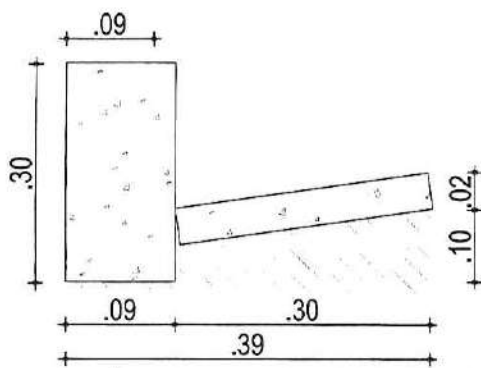
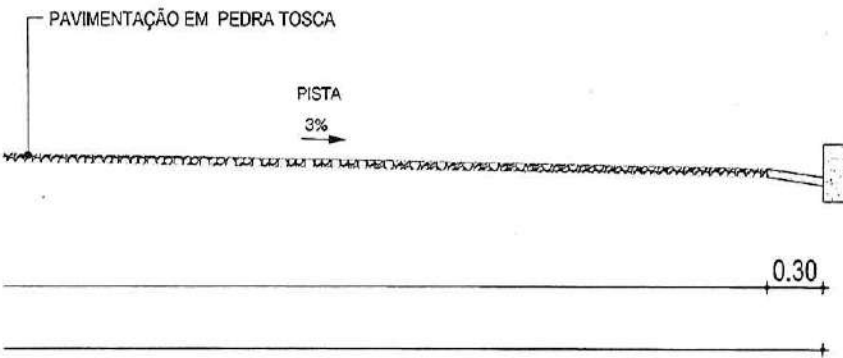

04 | DETALHE DA MEIO FIO CONJUGADO COM SARJETA  
 ESC.: 1/10

*Claudia Villas Bôas*  
 Claudia Villas Bôas  
 Eng. Civil  
 CREA-CE 13252-0



PROJETO	PAVIMENTAÇÃO EM PEDRA TOSCA
CLIENTE	GOVERNO MUNICIPAL DE BANABUIÚ - CEARÁ
ENDEREÇO	AV CHICO HONÓRIO - PEDRAS BRANCA - MUNICÍPIO DE BANABUIÚ - CE
CONTEÚDO	SEÇÃO TIPO DE PAVIMENTAÇÃO - DETALHES CONSTRUTIVO - MEIO FIO PEDRA GRANÍTICA E SARJETADA DE CONCRETO
ASSUNTO	RESPONSÁVEL
DESENHO	DESENHO
PAVIMENTAÇÃO	CLAUDIA VILLAS BOAS
	SAM LIMA
DATA 15/05/2020	ESCALA
	S/E

PROJETO GEOMÉTRICO



RUA O  
PAVIMENT

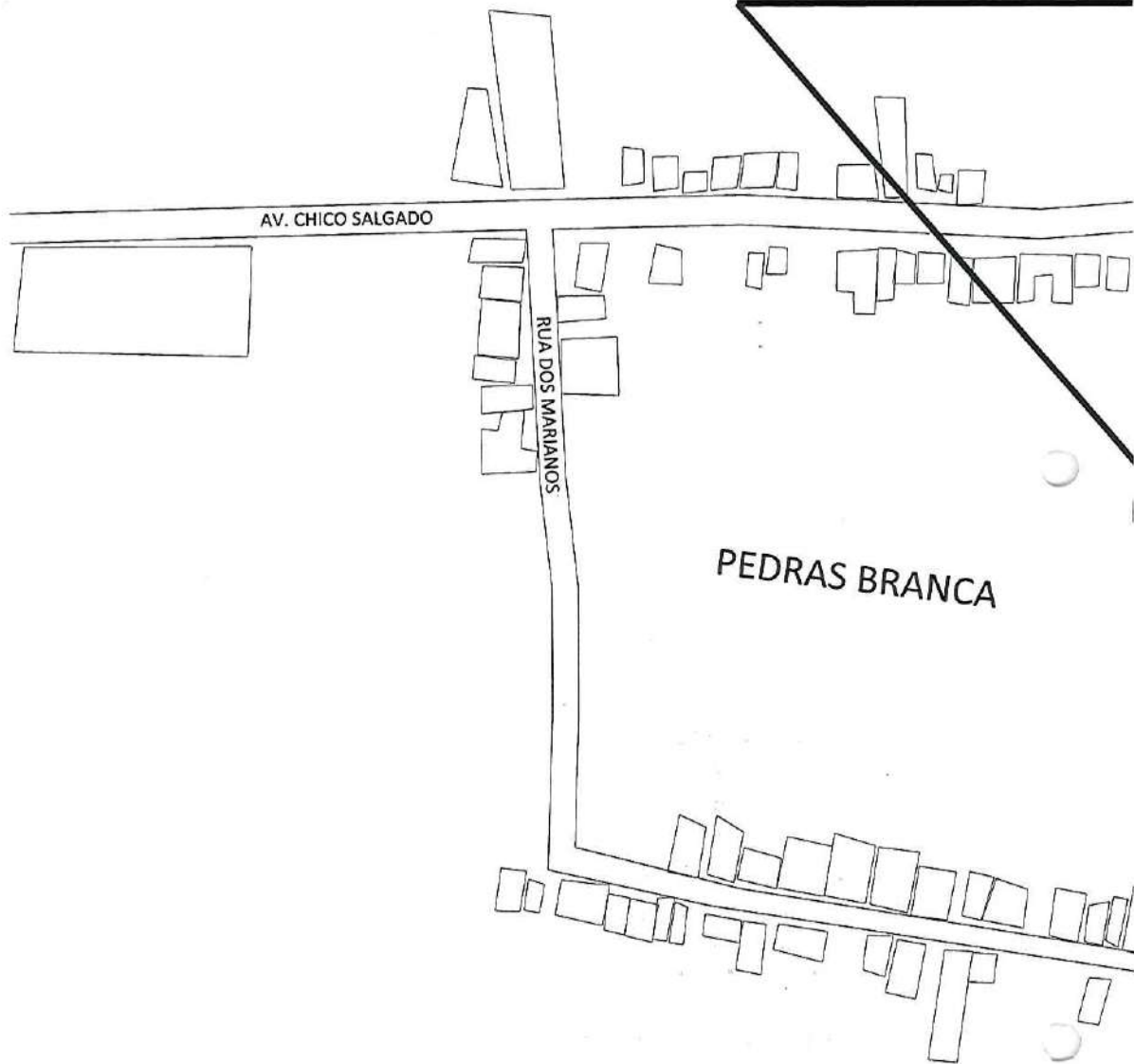

*Cláudia Vilas Boas*  
Cláudia Vilas Boas  
Eng. Civil  
CREA-CE 14365-D

PLANTA DE LOCALIZAÇÃO



PROJETO	MAPA DE LOCALIZAÇÃO	LEGENDA DO <input type="checkbox"/> LOCAL
CONTRATANTE	GOVERNO MUNICIPAL DE BANABUIÚ - CE	
ENDEREÇO	RUA OVIDEO MATHIAS - PEDRAS BRANCA - BANABUIÚ - CE	
CONTEÚDO	PLANTA DE LOCALIZAÇÃO	

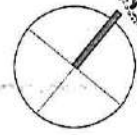

# ÍDEO MATHIAS ÇÃO EM PEDRA TOSCA



ALIZAÇÃO					
NO	LEGENDA PERFIL	RESPONSÁVEL	CLAUDIA VILLAS BOAS	DATA	MAI/2020
3	— PROJETO	DESENHO	SAM LIMA	ESCALA	S/E
	— TERRENO NATURAL		-	<b>01-03</b>	
			-		

PLANTA BAIXA  
Escala - 1:1000

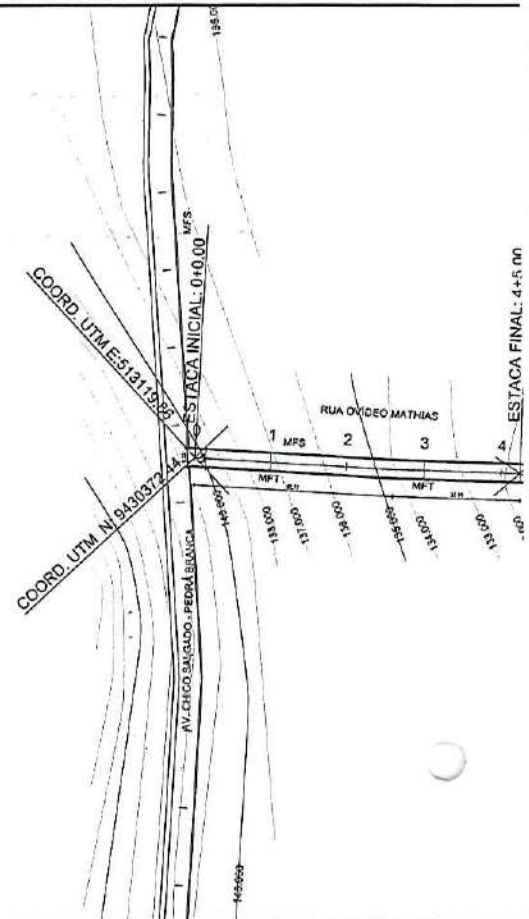

LEGENDA:

- (MFS) MEIO FIO COM SARJETA
- (MFF) MEIO FIO DE FECHAMENTO
- (MFF) MEIO FIO DE TRAVAMENTO

Escala horiz. 1:1000  
Escala vert 1:100

COTAS

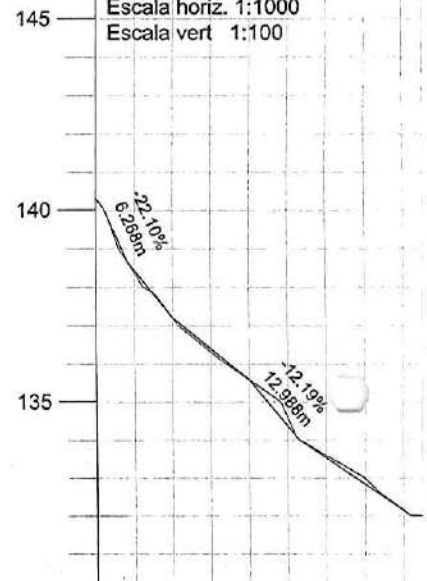

	ESTACAS	0	1	2	3	4
TERRENO		140,32	137,21	135,58	133,51	132,12
GREIDE		140,32	137,21	135,58	133,51	132,12
CORTE		0,00	0,00	0,00	0,00	0,00
ATERRO		0,00	0,00	0,00	0,00	0,00



PROJETO	PAVIMENTAÇÃO EM PEDRA TOSCA
CONTRATANTE	GOVERNO MUNICIPAL DE BANABUIÚ - CEARÁ
ENDEREÇO	RUA OVÍDEO MATHIAS - PEDRAS BRANCA - BANABUIÚ - CE
CONTEÚDO	PLANTA E PERFIL

PROJETO GE

LEGENDA PL

IMÓVE

AÇUD

VIAS I



AD. UTM N. 9430298.17



ORD. UTM E.513162.93

*Claudia Villas Boas*  
Cláudia Villas Boas  
Eng.ª CIVIL  
CREA-CE 24365-D

LÉGENDA				DATA	ESCALA
A	—x—x—	CERCA	RESPONSÁVEL	ABR/2020	INDICADA
	—	EIXO PROJETO	CLAUDIA VILLAS BOAS		
LAGOAS		BUEIRO CAPEADO	DESENHO		
CESSO		BUEIRO TUBULAR	EXTENSÃO		
			LARGURA		

02-03

TRECHO PIS  
RUA OVÍDEO MATHIA  
ESTACAS: 0+0.0

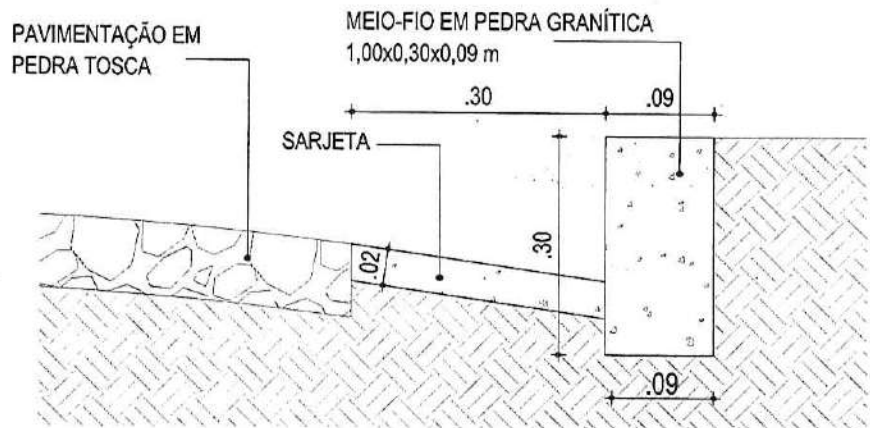
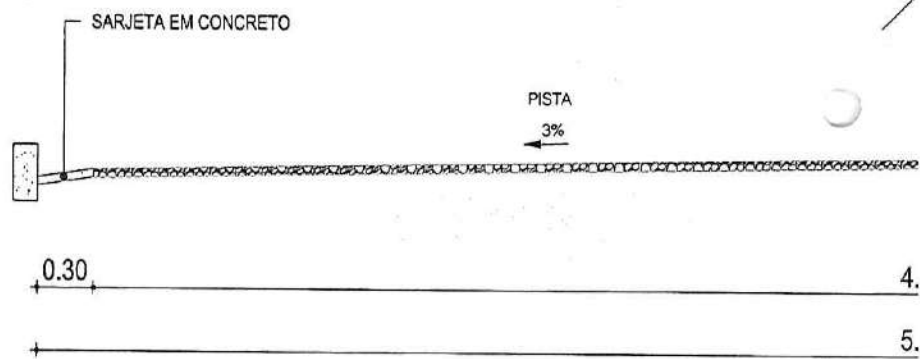

04 | DETALHE 04 - MEIO FIO CONJUGADO COM SARJETA  
ESC.: 1/10

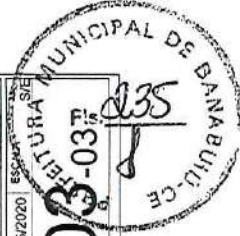

*Claudia Villas Boas*  
 Cláudia Villas Boas  
 Eng.ª Civil  
 CREA-CE 21335-0

TA SIMPLES  
 S - PEDRAS BRANCA  
 m À 4+5.00 m

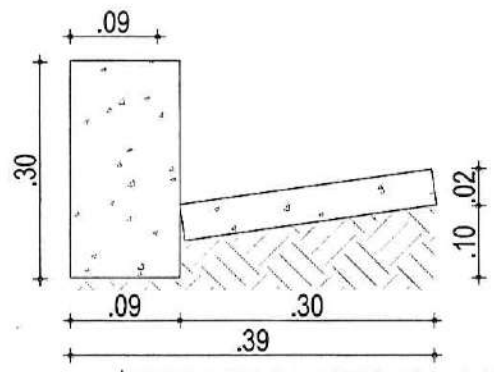
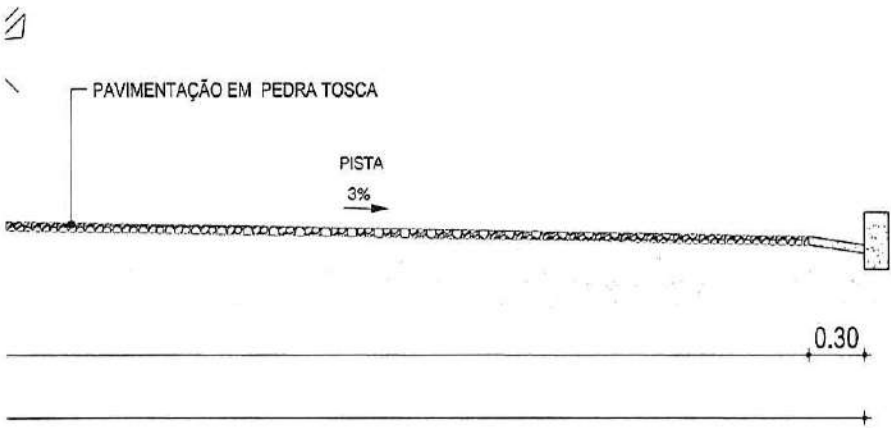

04 | DETALHE DA MEIO FIO CONJUGADO COM SARJETA  
 ESC.: 1/10

PROJETO GEOMÉTRICO

PROJETO	PAVIMENTAÇÃO EM PEDRA TOSCA
CLIENTE	GOVERNO MUNICIPAL DE BANABUIÚ - CEARÁ
ENDEREÇO	RUA OVIDEO MATHIAS - PEDRAS BRANCA - MUNICÍPIO DE BANABUIÚ - CE
CONTEÚDO	SEÇÃO TIPO DE PAVIMENTAÇÃO - DETALHES CONSTRUCTIVO - MEIO FIO PEDRA GRANÍTICA E SARJETA DE CONCRETO
ASSUNTO	PAVIMENTAÇÃO
RESPONSÁVEL	CLAUDIA VILLAS BOAS
DESENHO	SAMI LIMA





OBRA: PAVIMENTAÇÃO EM PEDRA TOSCA C/ CALÇADA EM CONCRETO  
ENDEREÇO: RUA SANTA LUZIA S/N - MUNICÍPIO DE BANABUIÚ  
DATA: 28.05.2020

RELATÓRIO FOTOGRÁFICO



Cláudia Vilas Bôas  
Eng<sup>o</sup> Civil  
CREA-CE 14965-0



*Cláudia Vilas Boas*  
 Cláudia Vilas Boas  
 Eng. Civil  
 CREA-CE 24365-0

PLANTA DE LOCALIZAÇÃO



PROJETO	MAPA DE LOCALIZAÇÃO	LEGENDA DO <input type="checkbox"/> LOCAL
CONTRATANTE	GOVERNO MUNICIPAL DE BANABUIÚ - CE	
ENDEREÇO	RUA SANTA LUZIA - PEDRAS BRANCA - BANABUIÚ - CE	
CONTEÚDO	PLANTA DE LOCALIZAÇÃO	

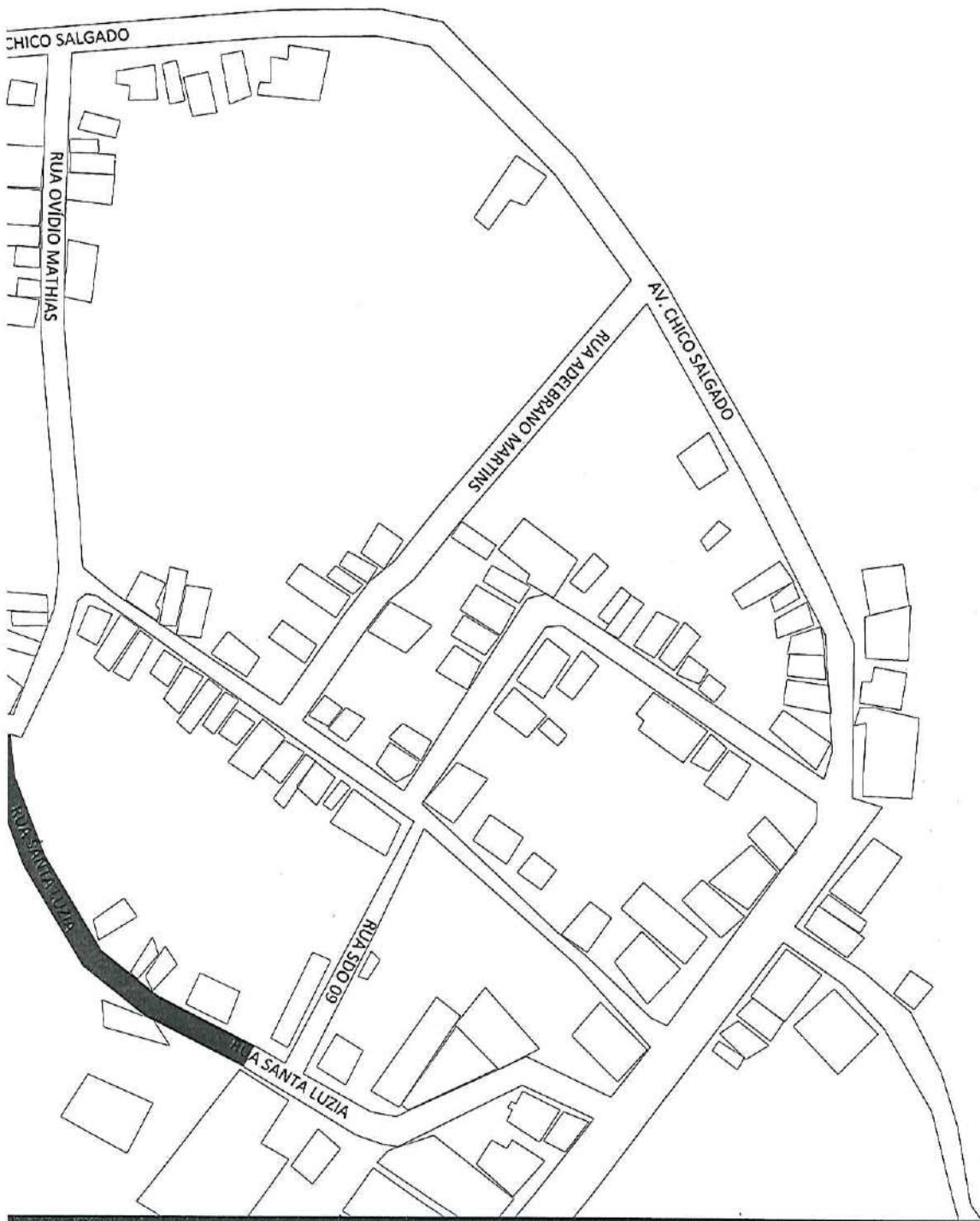

REALIZAÇÃO							
Nº 0	LEGENDA PERFIL	RESPONSÁVEL	CLAUDIA VILLAS BOAS	DATA	MAI/2020	ESCALA	S/E
	— PROJETO	DESENHO	SAM LIMA	<b>01-03</b>			
— TERRENO NATURAL							

PLANTA BAIXA  
Escala - 1:1000

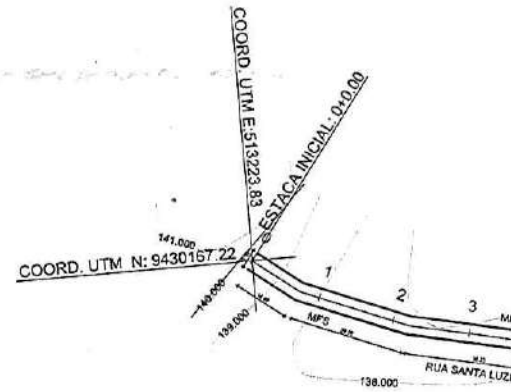

LEGENDA:

- (MFS) MEIO FIO COM SARJETA
- (MFF) MEIO FIO DE FECHAMENTO

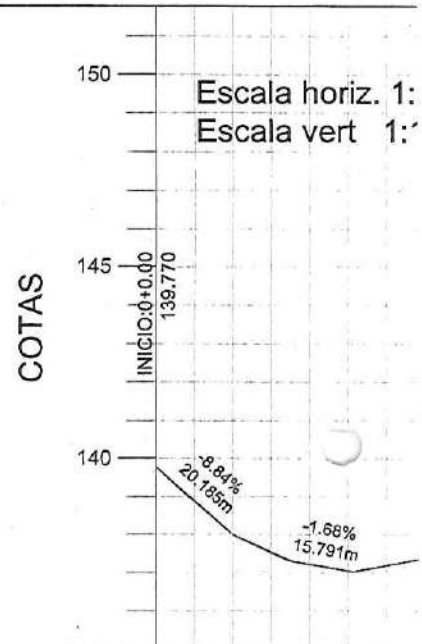

ESTACAS	0	1	2	3
TERRENO				
GREIDE	139,77	138,00	137,21	137,18
ATERRO	0,00	0,00	0,00	0,00

PROJETO	PAVIMENTAÇÃO EM PEDRA TOSCA
CONTRATANTE	GOVERNO MUNICIPAL DE BANABUIÚ - CEARÁ
ENDEREÇO	RUA SANTA LUZIA - PEDRA BRANCA - BANABUIÚ - CE
CONTEÚDO	PLANTA E PERFIL

PROJETO G:

LEGENDA P

- IMÓV
- AÇUC
- VIAS

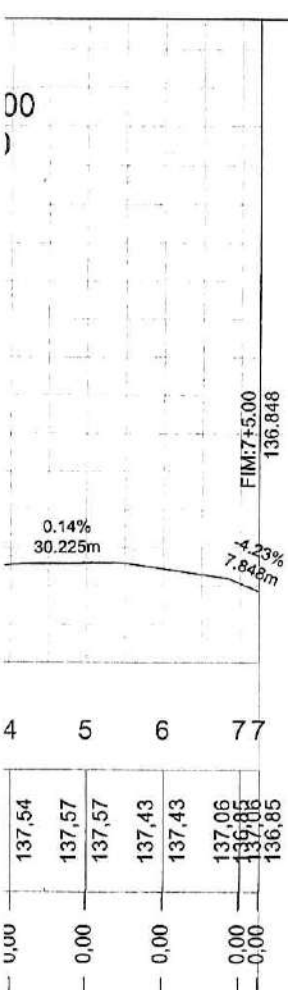
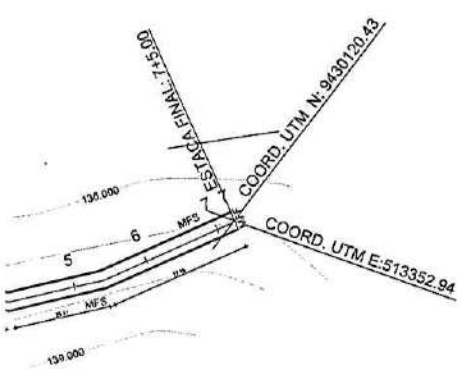

*Claudia Villas Boas*  
 Cláudia Villas Boas  
 Eng<sup>o</sup> Civil  
 CREA-CE 14365-D

MÉTRICO		LEGENDA PERFIL		RESPONSÁVEL	CLÁUDIA VILLAS BOAS	DATA	ESCALA
A	—X—X— CERCA	—— PROJETO	—— TERRENO NATURAL	DESENHO	SAM LIMA	ABR/2020	INDICADA
	—— EIXO PROJETO			EXTENSÃO	145,00m		
LAGOAS	(((			LARGURA	5,00 m		
CESSO	)))						
	))) BUEIRO TUBULAR						

**02-03**

TRECHO PI  
RUA SANTA LUZIA  
ESTACAS: 0+0.

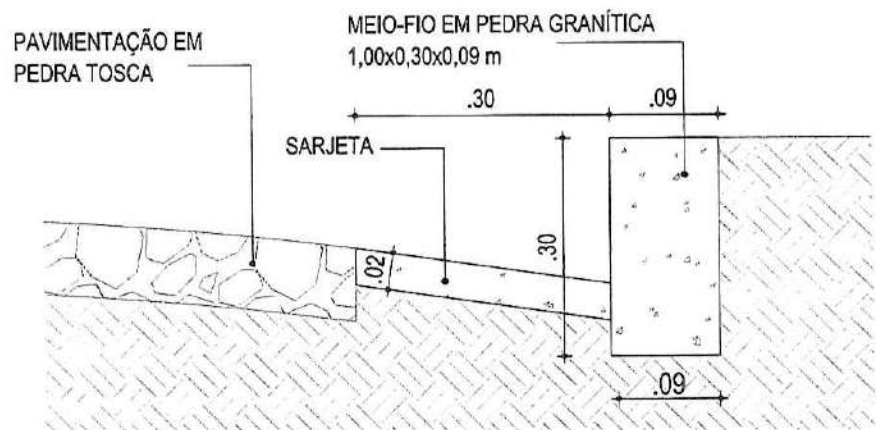
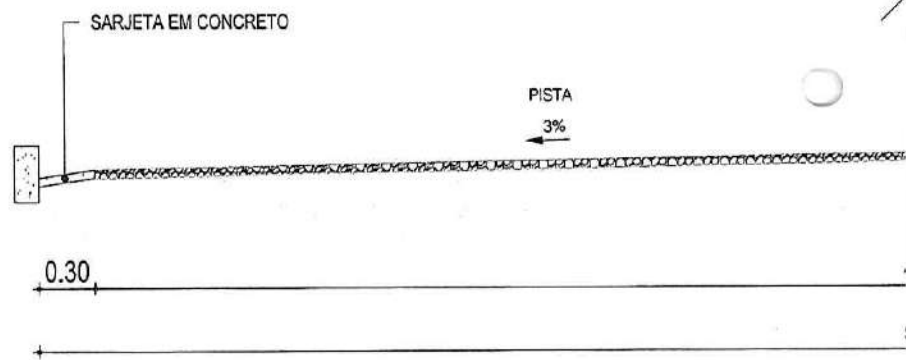

04 | DETALHE 04 - MEIO FIO CONJUGADO COM SARJETA  
ESC.: 1/10

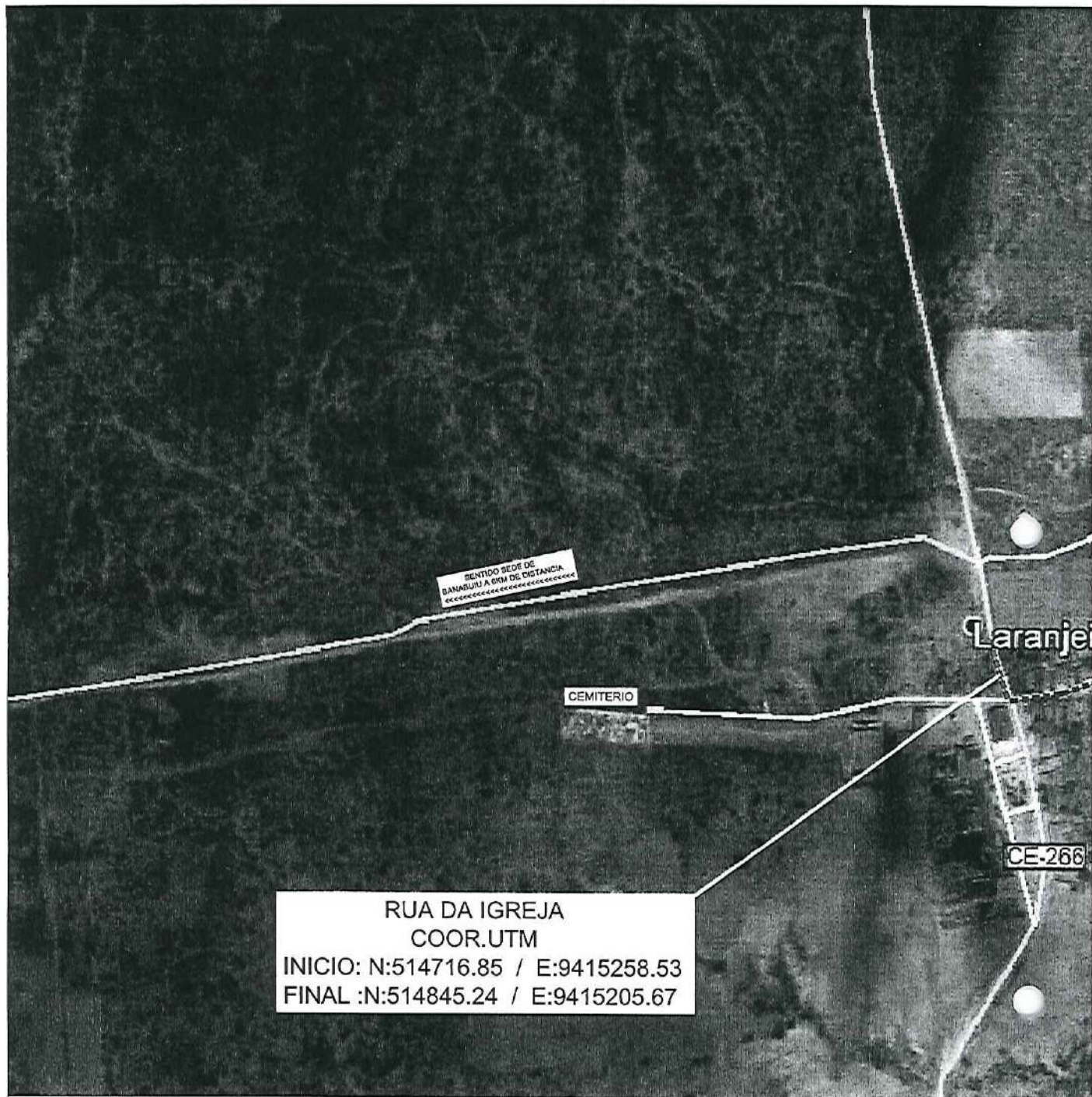

RUA DA IGREJA  
 COOR.UTM  
 INICIO: N:514716.85 / E:9415258.53  
 FINAL :N:514845.24 / E:9415205.67

RUA DA IGREJA -----  
 COOR.UTM  
 INICIO: N:514716.85 / E:9415258.53  
 FINAL :N:514845.24 / E:9415205.67

RUA ESTRADA DA PENHA -----  
 COOR.UTM  
 INICIO: N:514901.90 / E:9415220.61  
 FINAL : N:515030.28 / E:9415279.05



PROJETO	PAVIMENTAÇÃO EM PEDRA TOSCA -DISTRITO LARANJEIRA	LEGENDA P
CONTRATANTE	GOVERNO MUNICIPAL DE BANABUIÚ -CE	IMÓV
ENDEREÇO	RUA DA IGREJA E RUA ESTRADA DA PENHA	AÇU
CONTEÚDO	PLANTA DE LOCALIZAÇÃO	CURV

PROJETO G:

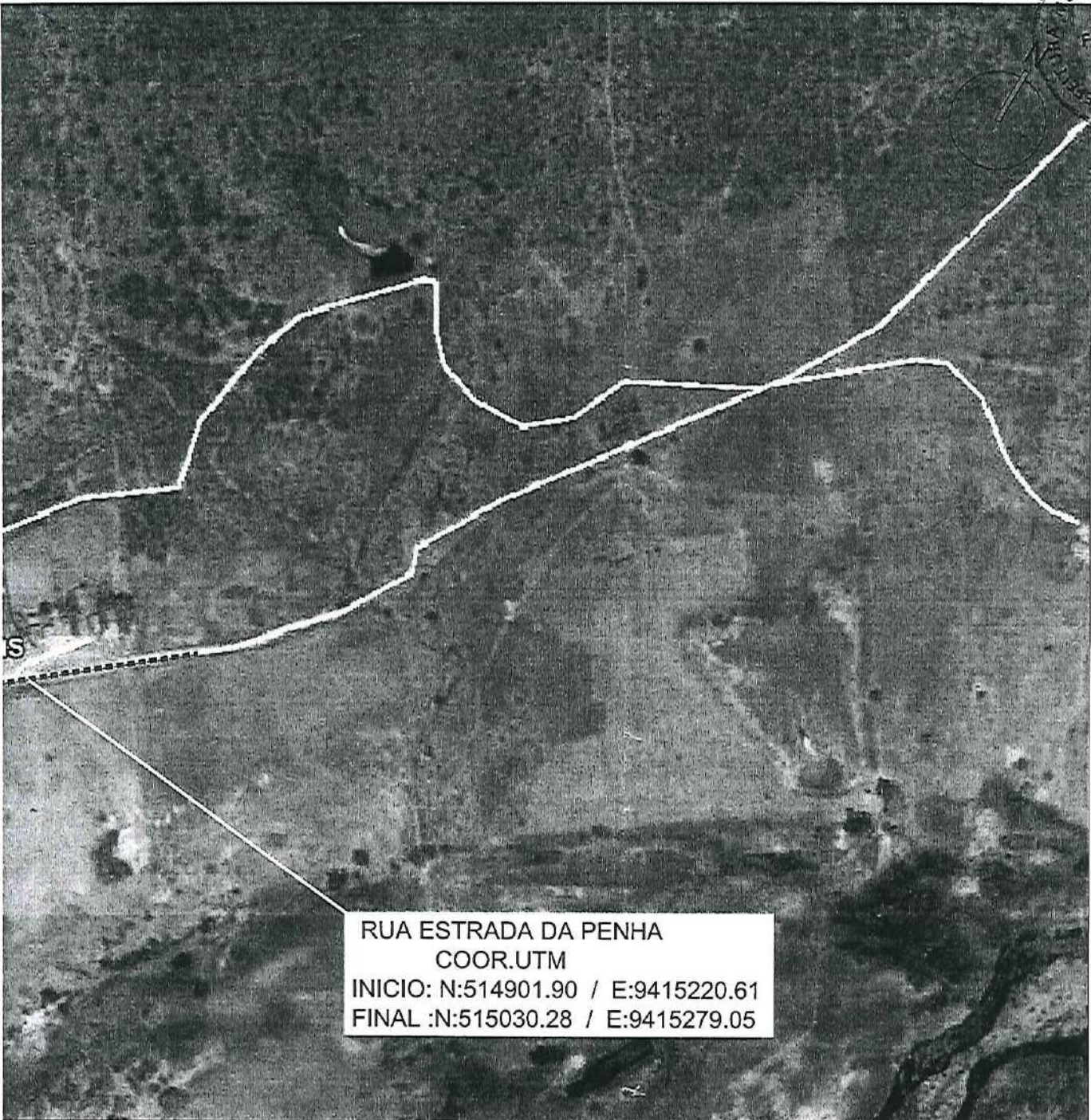

RUA ESTRADA DA PENHA  
 COOR.UTM  
 INICIO: N:514901.90 / E:9415220.61  
 FINAL :N:515030.28 / E:9415279.05

*Claudia Villas Boas*  
 Cláudia Villas Boas  
 Eng. Civil  
 CREA-CE 24365-D



MÉTRICO		LEGENDA PERFIL		RESPONSÁVEL	CLAUDIA VILLAS BOAS	DATA	MAIO/2020	ESCALA	INDICADA
— x — x —	CERCA	— — — — —	PROJETO	DESENHO	JOELSON MIRANDA	<b>01-03</b>			
— — — — —	EIXO PROJETO	—————	TERRENO NATURAL	EXTENSÃO	VARIADAS				
	BUEIRO CAPEADO			LARGURA	VARIADAS				
	BUEIRO TUBULAR								

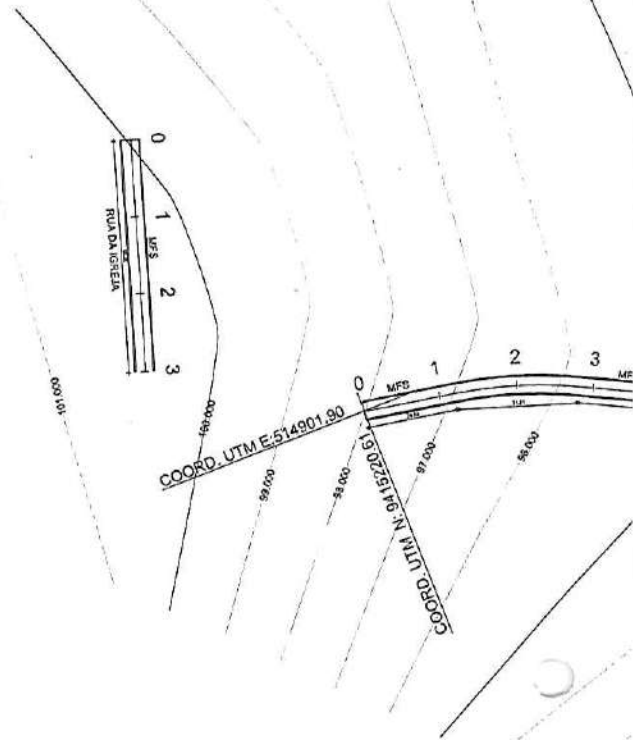

PLANTA BAIXA  
Escala - 1:1000

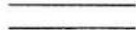

LEGENDA:

-  (MFS) MEIO FIO COM SARJETA
-  (MFF) MEIO FIO DE FECHAMENTO

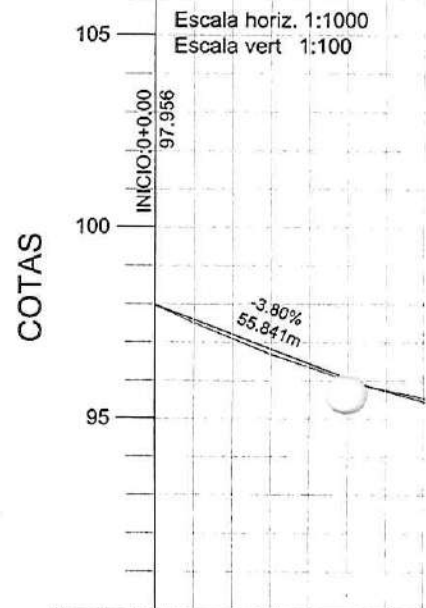



	ESTACAS	0	1	2	3
TERRENO	GR. DE	97,96	97,09	96,35	95,75
ATERRO		0,00	0,10	0,09	0,03



PROJETO	PAVIMENTAÇÃO EM PEDRA TOSCA
CONTRATANTE	GOVERNO MUNICIPAL DE BANABUIÚ - CE
ENDEREÇO	RUA ESTRADA DA PENHA
CONTEÚDO	PLANTA E PERFIL

PROJETO GE

-  IMÓVIL
-  AÇUC
-  VIAS

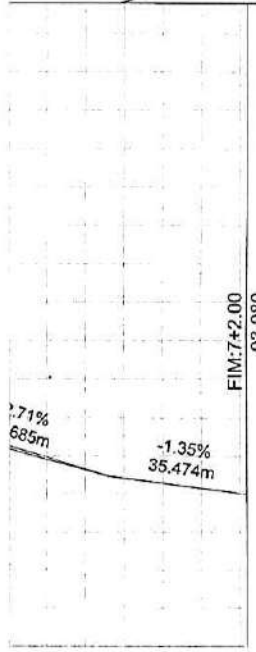
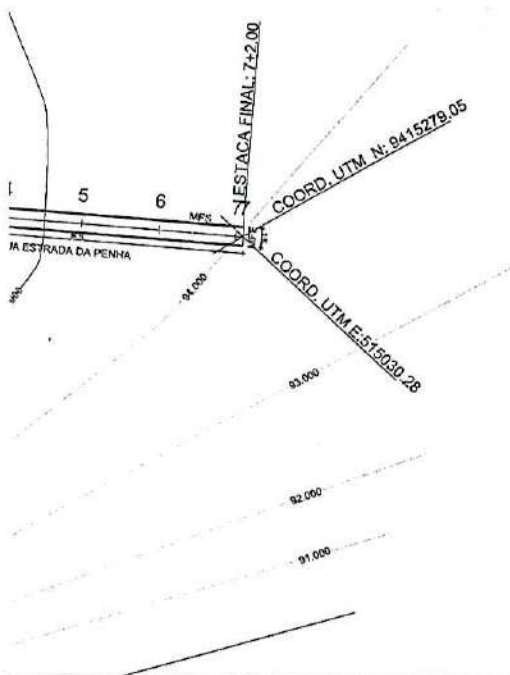

4	5	6	7
95,18	94,66	94,64	94,28
	0,03	0,00	0,60
			94,98
			93,98

*Claudia Villas Boas*  
 Cláudia Villas Boas  
 Engª Civil  
 CREA-CE 14365-D

MÉTRICO			
—x—x— CERCA	— PROJETO	RESPONSÁVEL	CLAUDIA VILLAS BOAS
— EIXO PROJETO	— TERRENO NATURAL	DESENHO	JOELSON MIRANDA
LAGOAS	BUEIRO CAPEADO	EXTENSÃO	142,00m
CESSO	BUEIRO TUBULAR	LARGURA	5,00 m
		DATA	MAIO/2020
		ESCALA	INDICADA
		02-03	

A SIMPLES  
PENHA - LARANJEIRAS  
m À 7+2.00 m

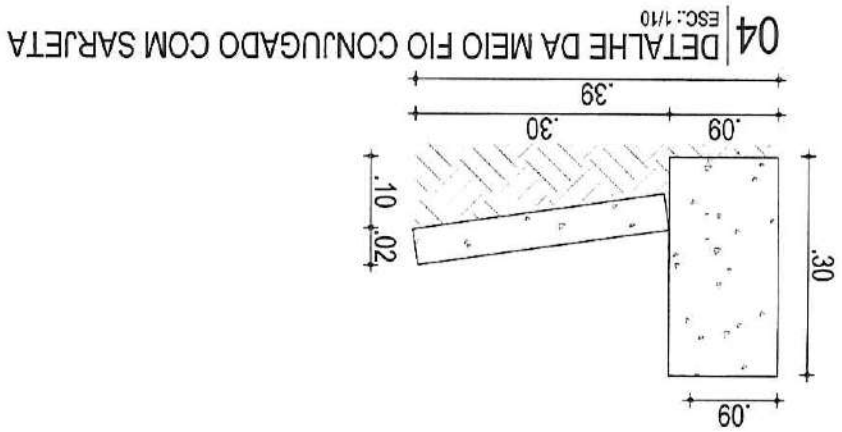
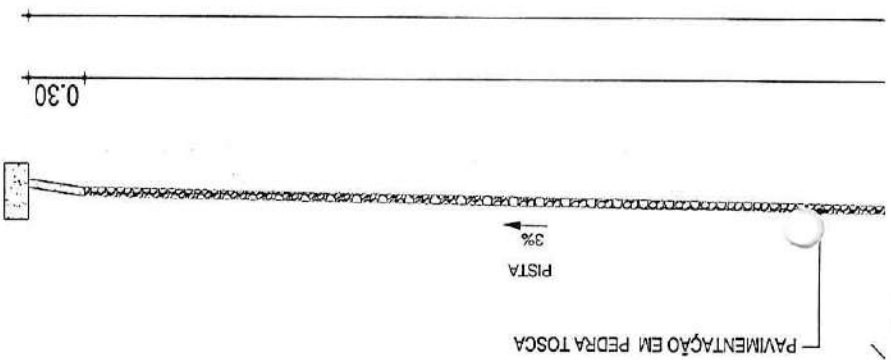

*Claudia Villas Boas*  
Claudia Villas Boas  
Eng.ª Civil  
CREA-CE 14355-0



PROJETO GEOMÉTRICO	
PROJETO	PAVIMENTAÇÃO EM PEDRA TOSCA
CLIENTE	GOVERNO MUNICIPAL DE BANABUIU - CEARÁ
ENDEREÇO	RUA DA ESTRADA DA PENHA - LARANJEIRAS - MUNICÍPIO DE BANABUIU - CE
CONTEÚDO	SEÇÃO TIPO DE PAVIMENTAÇÃO - DETALHES CONSTRUCTIVO - MEIO FIO PEDRA GRANÍTICA E SARJETA DE CONCRETO
ASSUNTO	PAVIMENTAÇÃO
RESPONSÁVEL	CLAUDIA VILLAS BOAS
DESENHO	SAMI LIMA

DATA 15/05/2020 ESCALA S/E  
03-03

04 | ESC: 1/10  
 DETALHE 04 - MEIO FIO CONJUGADO COM SARJETA

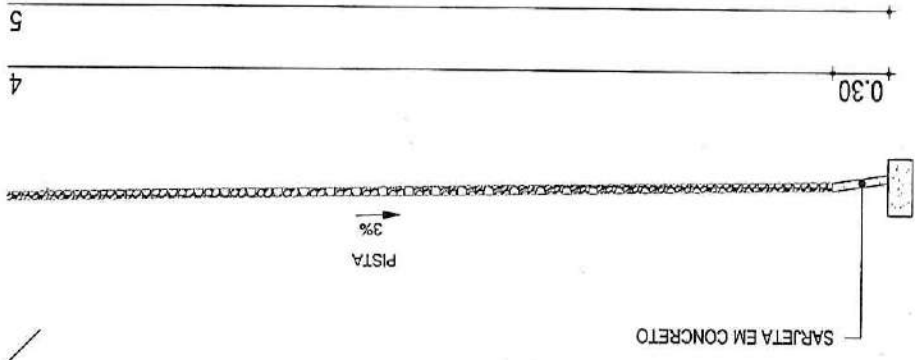
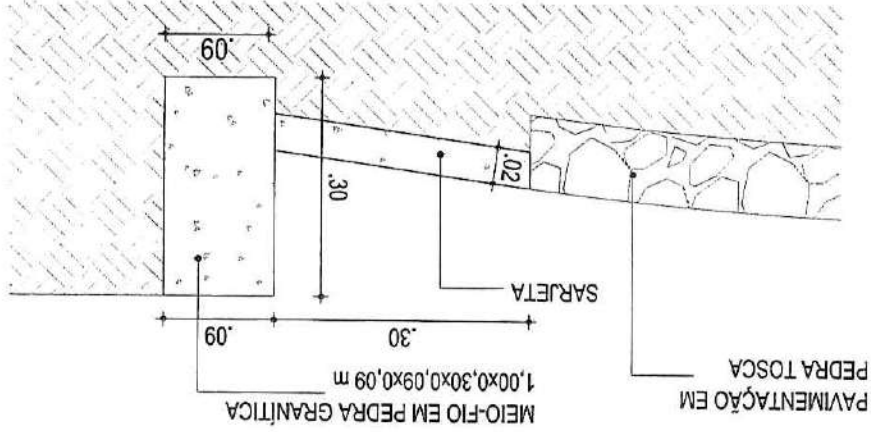

TRECHO PI  
 RUA DA ESTRADA D/  
 ESTACAS: 0+0,1

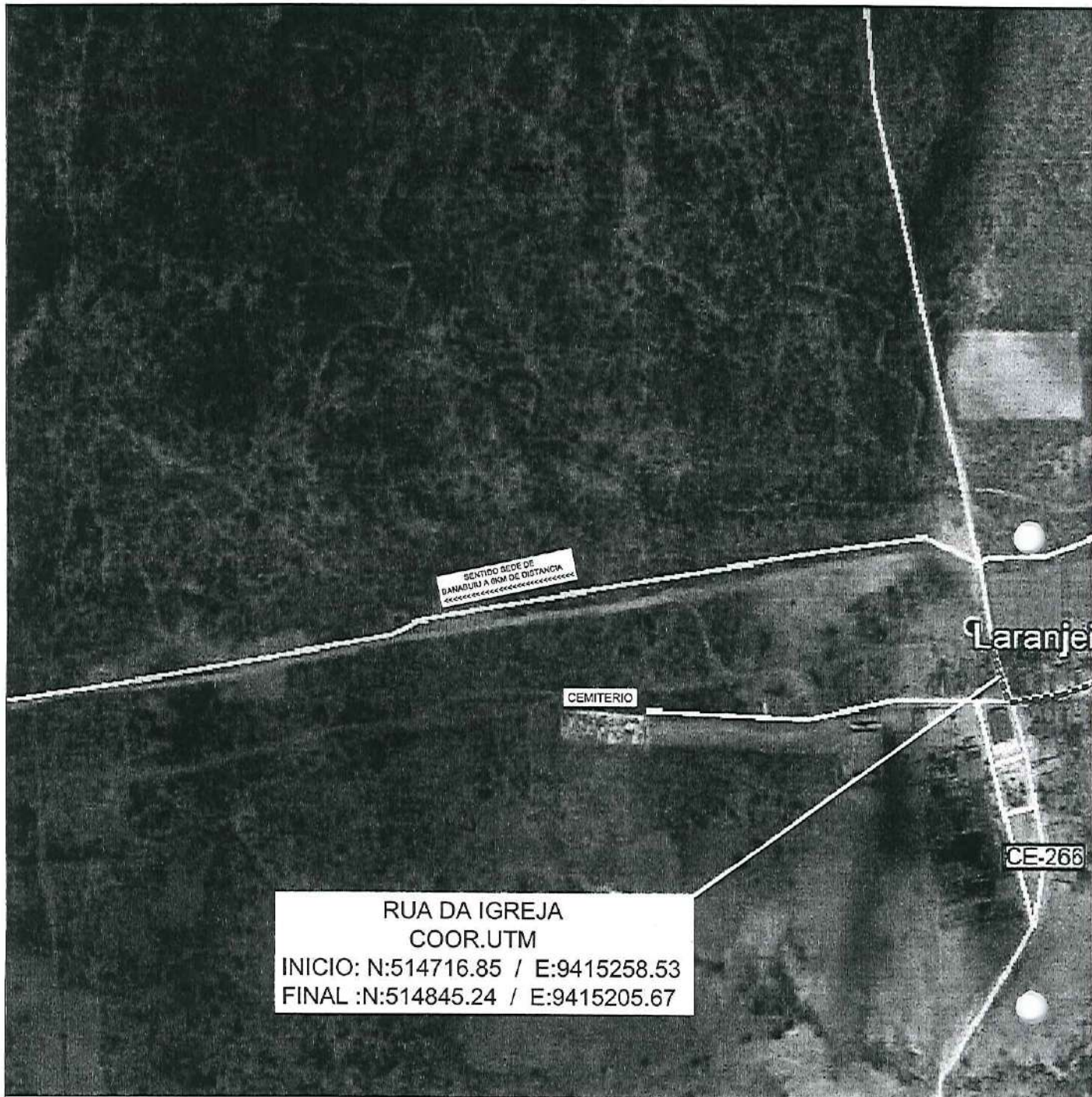

**RUA DA IGREJA**  
**COORDENADAS UTM**  
**INICIO: N:514716.85 / E:9415258.53**  
**FINAL :N:514845.24 / E:9415205.67**

**RUA DA IGREJA -----**  
**COORDENADAS UTM**  
**INICIO: N:514716.85 / E:9415258.53**  
**FINAL :N:514845.24 / E:9415205.67**

**RUA ESTRADA DA PENHA -----**  
**COORDENADAS UTM**  
**INICIO: N:514901.90 / E:9415220.61**  
**FINAL : N:515030.28 / E:9415279.05**



PROJETO	PAVIMENTAÇÃO EM PEDRA TOSCA -DISTRITO LARANJEIRA
CONTRATANTE	GOVERNO MUNICIPAL DE BANABUIÚ -CE
ENDEREÇO	RUA DA IGREJA E RUA ESTRADA DA PENHA
CONTEÚDO	PLANTA DE LOCALIZAÇÃO

PROJETO G

LEGENDA P
IMÓV
AÇUE
CURY



RUA ESTRADA DA PENHA  
 COOR.UTM  
 INICIO: N:514901.90 / E:9415220.61  
 FINAL :N:515030.28 / E:9415279.05

*Claudia Villas Boas*  
 Cláudia Villas Boas  
 Eng. Civil  
 CREA-CE 21365-D

METRICO		LEGENDA PERFIL		RESPONSÁVEL	CLAUDIA VILLAS BOAS	DATA	MAIO/2020	ESCALA	INDICADA
A	—x—x— CERCA	—— PROJETO	—— TERRENO NATURAL	DESENHO	JOELSON MIRANDA	01-03			
	----- EIXO PROJETO			EXTENSÃO	VARIADAS				
LAGOAS	BUEIRO CAPEADO			LARGURA	VARIADAS				
NIVEL	BUEIRO TUBULAR								

PLANTA BAIXA  
Escala - 1:1000

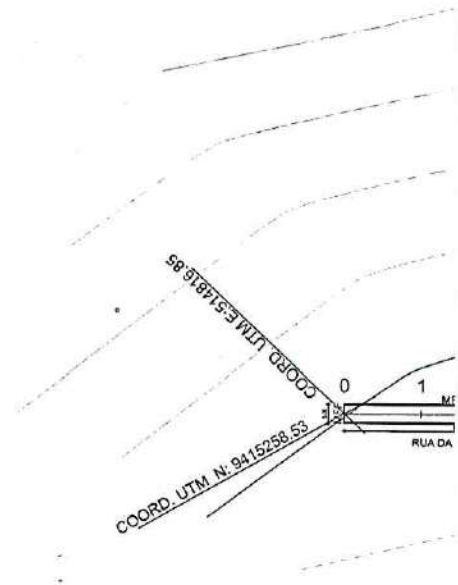

LEGENDA:

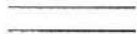
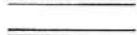
-  (MFS) MEIO FIO COM SARJETA
-  (MFF) MEIO FIO DE FECHAMENTO

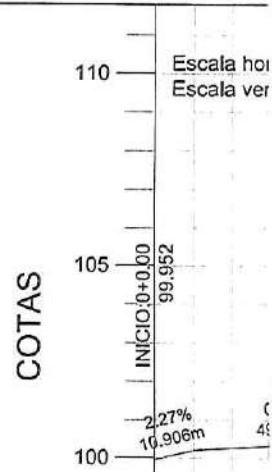

CORTE	ESTACAS	
	0	1
TERRENO	99,95	100,25
GREIDE	99,95	100,25
ATERRO	0,00	0,00





**GOVERNO MUNICIPAL DE BANABUIÚ**  
FAZENDO A MUDANÇA ACONTECER

PROJETO	PAVIMENTAÇÃO EM PEDRA TOSCA
CONTRATANTE	GOVERNO MUNICIPAL DE BANABUIÚ - CE
ENDEREÇO	RUA DA IGREJA
CONTEÚDO	PLANTA E PERFIL

PROJETO GE

LEGENDA PI

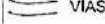
-  IMÓVEL
-  AÇUCAR
-  VIAS





TA SIMPLES  
 - LARANJEIRAS  
 1 m À 3+0.00 m

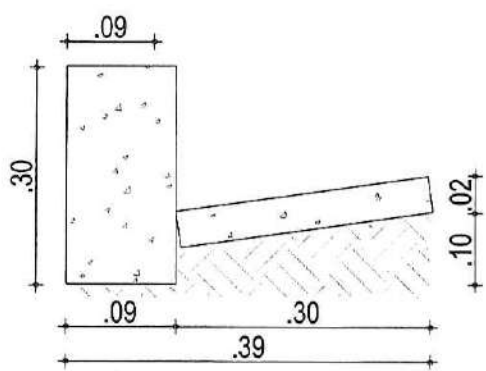
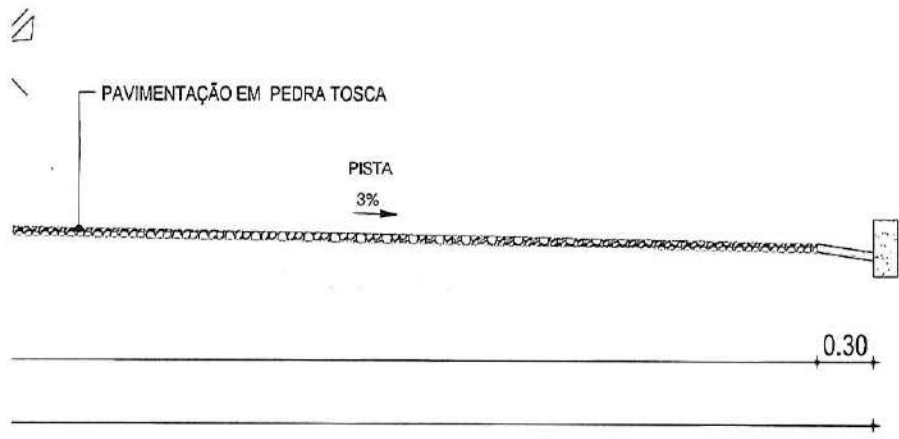

04 | DETALHE DA MEIO FIO CONJUGADO COM SARJETA  
 ESC.: 1/10

*Claudia Villas Boas*  
 Claudia Villas Boas  
 Eng. Civil  
 CREA-CE 21395-0

PROJETO GEOMÉTRICO		DATA: 15/05/2020	ESCALA	SE
PROJETO	PAVIMENTAÇÃO EM PEDRA TOSCA	RESPONSÁVEL	PAVIMENTAÇÃO	03-03
CLIENTE	GOVERNO MUNICIPAL DE BANABUIÚ - CEARÁ	DESENHO	CLAUDIA VILLAS BOAS	
ENDEREÇO	RUA DA IGREJA - LARANJEIRAS - MUNICÍPIO DE BANABUIÚ - CE		SAMI LIMA	
CONTEÚDO	SEÇÃO TIPO DE PAVIMENTAÇÃO - DETALHES CONSTRUTIVO - MEIO FIO PEDRA GRANÍTICA E SARJETA DE CONCRETO			



TRECHO PI  
RUA DA IGREJA  
ESTACAS: 0+0.

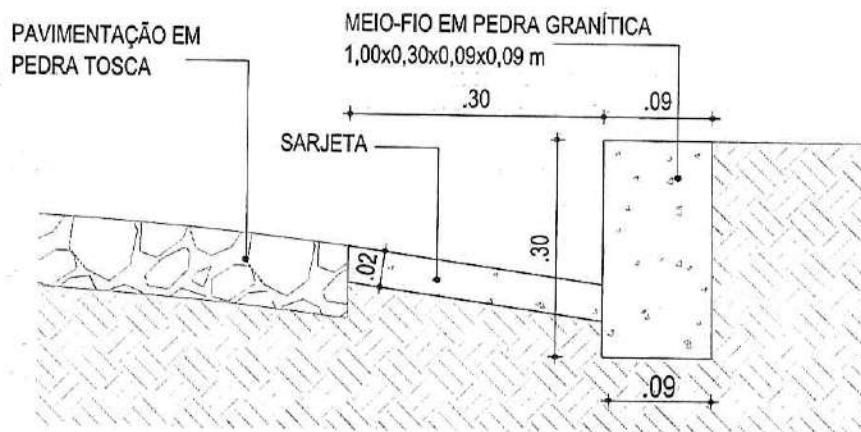
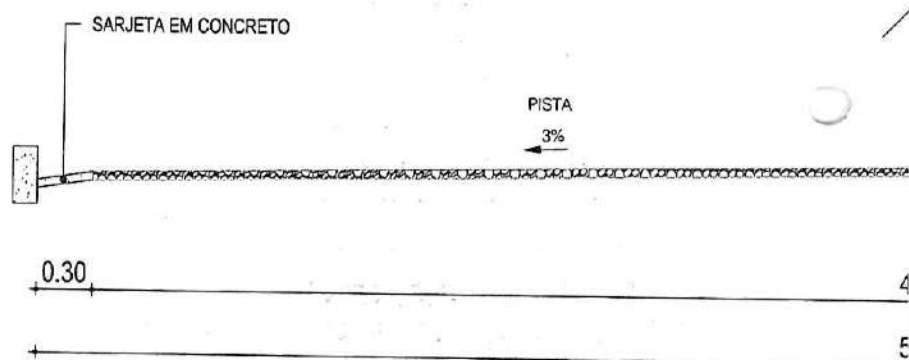

04 | DETALHE 04 - MEIO FIO CONJUGADO COM SARJETA  
ESC.: 1/10

